

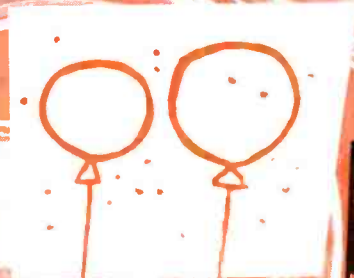

TAPE RECORDING

1958



TAPE YOUR
HOLIDAYS
DAILY CARE
OF RECORDERS

HAPPY
NEW
YEAR!

1958

SPECIAL!
TAPE
COPYING
ATTACHMENT

January, 1958

35c

They're crazy about the C-slot reel!

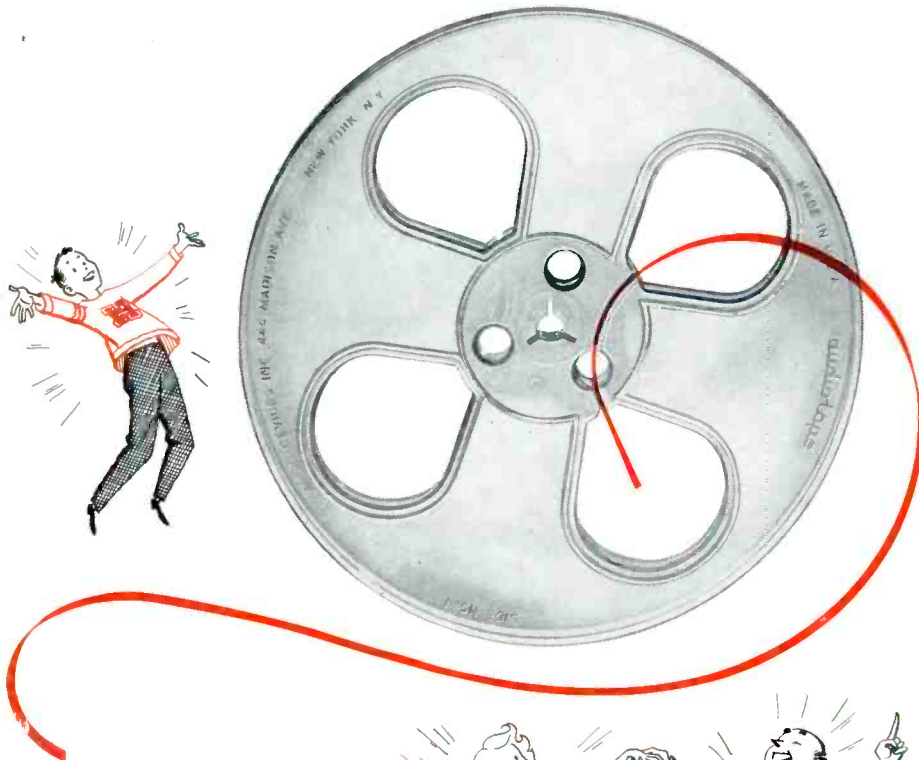

Tape fans give enthusiastic reply to survey on new easy-threading reel

WHEN our research engineers developed the C-Slot reel, we were so convinced that it was the perfect solution to tape-threading problems that we put it into immediate production. But just to confirm our own enthusiasm, we sent out samples to 260 independent tape recorder owners — professional, educational and home recordists throughout the country. We asked them to test the new reel and tell us how they liked it.

So far, 203 persons have responded. Of these, 189 gave us their spirited approval. That's

93%. The remaining 14 indicated merely that they were neutral. There was not a single negative rating.

It seems to us that this survey, like Audiotape, "speaks for itself." They're crazy about the C-Slot reel! Just look at the comments quoted at the right.

If you haven't yet tried the C-Slot reel, get a 7-inch reel of Audiotape from your dealer and see for yourself. You'll be getting America's finest quality recording tape on the most convenient reel ever designed.

COMMENTS

"I hope the C-Slot reel will be used exclusively for your recording tape."

M. S. • Columbus, Ohio

"We find it especially easy to handle with big fingers."

E. G. A. • Platteville, Wisc.

"I think it is a great improvement over any other reel now on the market."

C. D. B. • Quarryville, Pa.

"Best to date. You have overcome one of the nuisances of tape recording."

R. H. B. • Bronx, N. Y.

"Also holds tape better."

L. A. • Fairlawn, N. J.

"It's about time someone improved the reel. I think it's the greatest."

E. B. A. • Los Angeles, Calif.

"Crazy!"

J. R. C. • Decatur, Illinois

"Very nice reel — good, clean appearance, and physically strong. A pleasure to use."

A. R. A. • Whippany, N. J.

"Threading tape on a reel never was a world-shaking problem. But it was bothersome and messy until your genius produced this. Time saving and beautiful in its simplicity."

B. R. • Phila., Pa.

"At last, 'the' answer to the threading problem."

E. R. A. • Caldwell, N. J.

audiotape
TRADE MARK

it speaks for itself

AUDIO DEVICES, INC., 444 Madison Ave., New York 22, N.Y.

In Hollywood: 1006 N. Fairfax Ave.
In Chicago: 5428 Milwaukee Ave.
Export Dept.: 13 East 40th St., N.Y. 16, N.Y.
Cables "ARLAB"

Electro-Voice[®] DYNAMIC MICROPHONES

OUT-PERFORM ALL OTHERS in the RECORDING FIELD!

new acoustic principle – VARIABLE D acclaimed the most significant microphone development in 20 years!

Because of their durability and uniformity of response, dynamic microphones are almost universally used by recording studios. Electro-Voice dynamic microphones are a triumph of electro-acoustics in the recording, P.A. and general purpose fields. One of the many reasons for this is the Variable D principle which employs three distinct sound entrances, with acoustical filters; achieves flat response and excellent back cancellation while eliminating boominess caused by close talking—and susceptibility to shock. That's why those who want true fidelity, life-like recorded tape choose Electro-Voice dynamic microphones.



① E-V MODEL 664

Utilizing the revolutionary Variable D, this high-fidelity cardioid dynamic brings broadcast quality to tape recording and the P.A. and general purpose field. Proper placement of microphone stops unwanted sounds, gives accurate, natural pick-up of voice and music. Unprecedented ruggedness largely eliminates possibility of accidental damage.

Indestructible Acoustalloy diaphragm and precision manufacture assure long-life and dependable performance. Frequency response: 40 to 15,000 cps. Pressure cast case. Chrome finish. 18' cable. Size: 7-3/16" long, 1 7/8" diameter. Net weight: 1 lb. 10 oz. List price: \$85.00 (less stand).

② E-V MODEL 636

This model brings style and quality to the recording and public address fields. Slim and trim—only 1 1/8" in diameter x 10 1/4" long—it greatly reduces recording staging problems. Frequency response: 60 to 15,000 cps, essentially flat. Adjustable impedance. Gold or satin chrome finish. On-off switch standard equipment. Net weight: 15 oz. List price Chrome Finish: \$72.50 (less stand).

③ E-V MODEL 623

Excellent for both speech and music, its small, slim size makes it inconspicuous and easy to handle. Swivel mounting permits tilting microphone through a 57° arc toward the sound source. Acoustalloy diaphragm. Frequency response: 60 to 12,000 cps. Satin chrome finish. Net weight: 1 lb. List price: \$57.00 (less stand).

④ E-V MODEL 630

This is similar to Model 623 in performance characteristics but is traditionally styled. Frequency response: 60 to 11,000 cps. Satin chrome finish. Net weight: 1 lb. List price: \$52.50.

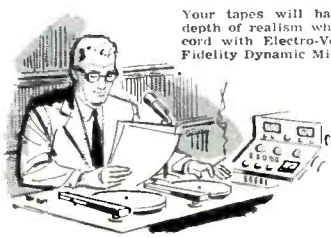

Your tapes will have a new depth of realism when you record with Electro-Voice High-Fidelity Dynamic Microphones!



See your E-V hi-fi dealer today. Write for "The ABC's of Microphones," Booklet HT81.

Electro-Voice[®]

**ELECTRO-VOICE, INC.
BUCHANAN, MICHIGAN**



PROTECT...

IDENTIFY...

TAPE RECORDINGS

with Soundcraft Mylar* Base Colored Leader Tape

Splice to both ends of your tapes... professionals do! Prevent disastrous torn or creased ends... make the entire length of your tape usable for recording... absorb stress and strain on the leader, at the start and finish of reels... make threading easier! Splice between recorded sections to indicate where any selection starts and finishes. In 4 colors... gold, blue, red, white... color code your recordings! Use one color for instrumental music... another for vocals... identify your tapes at a glance no matter how many times they are wound from reel to reel! Ask your dealer for Soundcraft "Mylar" base COLORED LEADER TAPES... write for Folder RS57-2.

REEVES SOUND CRAFT CORP.

10 E. 52nd St., New York 22, N.Y.
W. Coast: 338 N. LaBrea, L.A. 36, Cal.

R 24

*DuPont T.M.

HI-FI

TAPE RECORDING

VOL. 5 NO. 2

JANUARY 1958

MARK MOONEY, JR.
Editor and Publisher

JOHN L. ALLEN
Circulation Manager

JEAN COVER
Assistant Editor

ROBERT W. LAPHAM
Art Director

JAMES H. MILLS, SR.
Technical Consultant

ANTHONY J. MORIN, JR.
National Advertising Manager
274 Madison Ave., New York 16, N. Y.

GEORGIE SIGSBEE
Music Editor

IN THIS ISSUE

TAPE YOUR HOLIDAYS	Jean Cover	16
HEARTS ON TAPE	R. E. Atkinson	20
DAILY CARE OF TAPE RECORDERS	Joseph Zelle	24
TAPE COPYING ATTACHMENT	Buford Frye	26
NEW TAPES	Georgie Sigsbee	6
NEW PRODUCTS		11
TAPE IN EDUCATION	John J. Grady, Jr.	13
QUESTIONS AND ANSWERS		14
TAPES TO THE EDITOR		15
TAPE CLUB NEWS		29
NEW PRODUCT REPORT: PENTRON TAPE COMPONENTS		30
TEEN TAPERS	Jerry Heisler	33



HI-FI TAPE RECORDING is published monthly by Mooney-Rowan Publications, Inc., Severna Park, Md. (Severna Park 548). Entered as second class matter January 7, 1954 at the Postoffice, Severna Park, Md., under the Act of March 3, 1879. National Advertising Representative: J-V Associates, 274 Madison Ave., New York 16, N. Y. (ORegon 9-0030). Subscriptions, U. S. and Possessions, Canada and Mexico, \$3.75 for one year; all others add \$1.00 a year. Two years \$7.00. Contents copyrighted by Mooney-Rowan Publications, Inc., 1957. Printed in U. S. A.

POSTMASTER—Send all address labels clipped from undeliverable copies with Form 3579 to Hi-Fi Tape Recording, Severna Park, Md.

this Christmas gift is yours...

when you buy **SOUNDCRAFT TAPE**

fill your home with

♪ **SOUNDS OF CHRISTMAS** ♪

a high fidelity recording on your
own reel of Soundcraft Tape!

Adeste Fideles
Silent Night
**Rudolph the Red
Nosed Reindeer**
Noel
Jingle Bells
**God Rest Ye
Merry Gentlemen**

performed by
The Street Singer
Caroleers, orchestra and
chorus under the
direction of world famous
arranger-composer
Dewey Bergman.

**The Spirit of Christmas
Captured in Sound!** —
the best-loved of
traditional Christmas
melodies...joyous...
nostalgic...reverent...
as much a part of the
holiday season as
decorations on the tree!

**A collector's item...
not for sale at any price**
...this 15-minute
high fidelity recording
is yours **FREE**, except
for postage and
handling, when you buy
any 7" reel of
Soundcraft Tape. See
your Soundcraft dealer
now, or write us for
his name...he will tell
you how you can get
"SOUNDS OF CHRISTMAS"
recorded on your tape.
Not only the
"SOUNDS OF CHRISTMAS"
but the sounds of all
the year sound better
on Soundcraft Tape!



REEVES

SOUNDCRAFT

CORP.

10 E. 52nd St., New York 22
West Coast—338 N. LaBrea,
Los Angeles 36, Calif.

NEW TAPES

By Georgie Sigsbee

STEREOPHONIC

CLASSICAL SYMPHONY

SCHUBERT

Symphony #8 in B Minor ("Unfinished")

Philharmonic Symphony Orchestra of London
Artur Rodzinski, Conductor

SONOTAPE SWB 8024
Stereo... \$11.95... 25 mins.

Rodzinski gives a quiet, poetic reading to this symphony. Its nature is sweet and in his interpretation he leans on this aspect, bringing out the warmth and sentiment of the appealing melodies. For those who prefer a slow-paced Allegro and a recording filled with broad, rich, string work, this recording certainly has these attributes.

On the other hand, for those who desire a more dynamic Allegro, Gui's should suffice. (Audiosphere 701, June '54 and 701 BN, April '55). The choice is up to individual taste.

Rodzinski is granted fine stereo reproduction.

CONCERTO

BACH

Concerto for Two Violins and String
Orchestra in D Minor

Saschko Gawriloff and
Friedrich Wuehrer, Violinists
Hamburg Chamber Orchestra
Walter Goehr, Conductor

CONCERT HALL EX-46

Stereo... \$8.95... 18 mins.

Gawriloff and Wuehrer perform with spirit and sensitivity. The orchestra under Goehr's baton performs vivaciously and the net result is a well-blended, thoroughly satisfactory reading.

The sound is clear and distinct.

Concert Hall has introduced a smart new red, white, and black box for their tapes as well as new opaque gray plastic reels. They have also changed their stereo numbers. In lieu of CHT/BN they now have prefixes; for example, BX-\$4.00, DX-\$6.95, EX-\$8.95, etc.

I would like to make one small suggestion to CH, and other companies not presently employing the following method. It would be more convenient if the beginning of the tape were swung to the outside of the reel case and then the tab to hold the tape placed thereon. This would eliminate having to dig into the reel case and work the tab loose. Someone might get their fingers stuck someday which might present a reel problem!

ORCHESTRAL

BRAHMS

Alto Rhapsody, Op. 53
Tragic Overture, Op. 81

Grace Hoffman, alto
North German Philharmonic Chorus and Orchestra
Carl Bamberger, Conductor

CONCERT HALL HX-39

Stereo... \$11.95... 25 mins.

Both of these compositions are well-mated since they are somewhat similar in mood. The "Rhapsody" is beautiful but melancholy, while the "Overture" is brilliant but has underlying tones of solemnity.

Miss Hoffman's splendid voice brings added glow to Brahms's. She is recorded in a forward position, the orchestra a bit back, but blended, and the chorus in the background. The sound is almost perfect.

There has been much speculation as to what tragedy Brahms had in mind when composing the "Overture." Some do not feel that this music is "tragic" at all. Be that as it may, it is music with depth and

An important new series from
the pioneer in stereo

Livingstonettes

Great new things are expected from the leader in any field . . . and so, Livingston introduces this outstanding new series of fine recordings for the stereophile.

Dramatically packaged in a new and beautiful container, each *Livingstonette* is a factory-sealed 5" reel containing the ultimate in stereo entertainment.

From any standpoint: performance, programming, engineering, packaging, OR price, *Livingstonettes* are unequalled.

Livingston's years of experience in producing fine stereo tapes make it possible to price these premium recordings at only

\$6⁹⁵

Below are listed the first releases of Livingstonettes, with many more to come:

DANCING ALONG IN STEREO	2001 C
Exciting Pop Dance Rhythms	
PEER GYNT SUITE	2002 C
Grieg's rich musical textures in a lavish stereo display.	
ENCHANTING STRAUSS	2003 C
More from our treasury of Strauss in Stereo.	
LENNY HERMAN GEMS	2004 C
Top favorites from our Lenny Herman group of "best sellers".	
MUSIC FOR A MIDNIGHT MOOD	2005 C
Soothing, easy-going Latin Americana for late evening reveries.	

All tapes are available either stacked or staggered.



LIVINGSTON AUDIO PRODUCTS CORP. Box 202 CALDWELL, N. J.

beauty. Bamberger and the orchestra render a dynamic performance building both the dramatic, as well as poignant, qualities.

The reproduction is excellent.

GRIEG

Two Elegiac Melodies

Pro Musica Symphony, Vienna
Edouard Van Remoortel, Conductor

PHONOTAPES Cameo SC 406

Stereo...\$4.98...9½ mins.

These two songs, "Heart Wounds" and "The Last Spring" are tender, soothing melodies. Remoortel supplies his usual expert, comprehending touch. As I recall "The Last Spring" is (was?) the theme for the TV show, "Mama."

The reproduced sound is of the best.

LISZT

Mephisto Waltz

Vienna State Opera Orchestra
Hermann Scherchen, Conductor

SONOTAPE SWB 7007

Stereo...\$6.95...13 mins.

Scherchen takes his time to gather the sweeping rhythms and full instrumentation from this score. His pace is slower (by some 2 minutes) but his delineation is keener than on the Reiner tape recently reviewed. (RCA ACS-25 Oct. '57) It is in the middle section in particular that his interpretative power shines forth. He depicts the devil's sweet temptation, at the same time pointing out the ominous consequences of getting involved with the fellow. Reiner's reading is faster all the way and, in my opinion, lacks sufficient tonal gradations.

Scherchen's subtle conducting of the very fine Vienna aggregation coupled with excellent fidelity, makes this an outstanding recording.

ORCHESTRAL—BALLET

KHACHATURIAN

Gayne Ballet Highlights

Vienna State Opera Orchestra
Hermann Scherchen, Conductor

SONOTAPE SWB 7008

Stereo...\$6.95...16 mins.

Khachaturian packed his "Gayaneh" ballet with brisk folkish dances native to Russia and Armenia. You will recall that the "Sabre Dance" became an all too recognizable fixture in the pop field some time ago. Scherchen has recorded here 5 of the 17 dances from the ballet; The Sabre Dance, Lullaby, Dance of Rose Maidens, Dance of Young Kurds, and Dance of the Kurds.

The "Volksoper" gets off to an energetic start and then simmers down for the Lullaby. From then on I would say that Scherchen takes the middle road and comes off with a good job. I have heard much more

pell-mell, high strung versions of the last two numbers. However, this recording may be a relief for many and certainly you are always fully aware of the splashing orchestral patterns cast by this intensely colorful music.

An excellent job of reproduction.

OVERTURE

TCHAIKOVSKY

1812 Overture

Vienna State Opera Orchestra
Hermann Scherchen, Conductor

SONOTAPE SWB 7002

Stereo...\$6.95...15 mins.

Scherchen works hard to achieve the romantic, as well as the militaristic, elements in this familiar work. The overall effect is a little drawn out, not as effectively compact nor as filled with dramatic excitement as Reiner's (RCA ACS-26, Nov. '57)

The crisp details of the instruments are entrancing to hear; the horns and percussive work, the bells and the cannons... all pack a tremendous audio thrill.

This is a beautifully recorded tape.

CHORAL

BRAHMS

A German Requiem, Op. 45

Terese Stitch-Randall, soprano
James Pease, baritone
The North German Philharmonic Chorus and Orchestra
Carl Bamberger, Conductor

CONCERT HALL RX-45

Stereo...\$23.90...1 hr. 9 mins.

This monumental choral work was completed by Brahms in 1868 when he was only thirty-five years old. It is said to have been composed in memory of his close friend, Robert Schumann. While he was working on the "Requiem," his mother passed on and his sorrow at her loss is also reflected in the music. Unlike other liturgical Masses for the dead, this composition offers no prayer for the deceased. The text is based on the Bible and is sung in German, rather than Latin.

This magnificent, deeply reflective work is one of the most beautiful stereo tapes it has ever been my pleasure to review. The choir, soloists, and orchestra give an impressive performance.

Miss Stitch-Randall's lovely soprano solo "Ihr habt nun Traurigkeit" ("And Ye Now Therefore Sorrow") is portrayed with poignancy. Her voice is not one of great strength but is refined and pleasant to hear.

Mr. Pease possesses a fine baritone voice. He sings his two solos with clarity and discernment.

The choir and orchestra follow through with an excellent job. For me, the emotional effect of this music is beyond words.

Concert Hall provides brief guide notes outlining the participants, the Book from

It's Christmas

ON CAPITOL STEREO TAPE



THE MUSIC OF CHRISTMAS:

Hollywood Bowl Symphony Orchestra
Carmen Dragon conducting

All the joy and splendor of the Season in breathtaking stereo—reverently beautiful symphonic arrangements of traditional carols. (ZF-14)

JOY TO THE WORLD:

The Roger Wagner Chorale
Moving old-world interpretations of universally beloved carols. (ZF-15)

Classical "FDS" Releases

LEOPOLD STOKOWSKI:

The Orchestra (ZH-8)

ROGER WAGNER CHORALE:

House of the Lord (ZF-9)

WM. STEINBERG, PITTSBURGH SYMPHONY:

Toch: Third Symphony (ZF-7)

HOLLYWOOD BOWL SYMPHONY ORCHESTRA:

L'Italia (ZF-3)

Gypsy (ZF-6)

Symphonic Dances (ZF-5)

Bolero & Capriccio Espagnol (ZF-4)

Popular Artists

NAT "KING" COLE:

Love is the Thing (ZD-11)

KENTON IN HI-FI (ZD-10)

GEORGE SHEARING:

Black Satin (ZC-13)

FRED WARING & THE

PENNSYLVANIANS IN HI-FI (ZD-12)

Specialties

A STUDY IN STEREO

A breathtaking showcase of stereo's vast range featuring Capitol's big-name artists. (ZH-2)

INTRO TO STEREO

A narrated journey through the wonders of stereo—music and real-life sounds. (ZA-1)



2 CHANNEL — 7½ IPS — FOR IN-LINE HEADS

Omega stereo puts you in the center of the sound



ANDRE MONTERO AND HIS ORCHESTRA IN STEREO PUTS YOU OUT OF THIS WORLD (IN THE MIDDLE OF PARIS)

Omega tape
HOLLYWOOD



PARIS DANCES BY NIGHT
ST-50 \$8.95
Andre's orchestra plays Can Can, Autumn in Paris, Along the Seine and others

ALLIED has the BEST BUY IN THIS GREAT TAPE RECORDER



only **\$94.95**

- Push-Button Operation
- Transistorized Pre-amplifier

ALLIED'S own PORTABLE KNIGHT AUTOMATIC TAPE RECORDER

Judged "Best Buy" among recording experts. Features Push-Button keyboard for instant recording with remarkably faithful reproduction. Has 2-speed dual-track recording mechanism and efficient erase system. Records up to 2 hours on standard tape (3 hours on long play). For instant playback, just push a button; also push-button control of forward, reverse and stop functions. Records from mike, radio or phono. Built-in quality amplifier and speaker. Simple to operate. Compact—only 23 lbs. With microphone. 600-ft. reel of tape and take-up reel. **91 RZ 751. Only \$94.95**

Free!

404-PAGE 1958 ALLIED CATALOG

Buying guide to everything in electronics, including all equipment for the tape recorder: complete recorders, basic mechanisms, amplifiers, mixers, mikes, heads, phone pickups, tape, splicers, and accessories. Write for your **FREE** copy of the 1958 ALLIED Catalog.



ALLIED RADIO
100 N. Western Ave., Dept. 83-A8
Chicago 80, Ill.

the Bible, and the quotation from the Book, which form the theme for each of the seven movements.

The reproduction is of the highest quality and the performance one of the best I have heard.

POPULAR

LAVALLE IN HI FI

- Clarinet Polka
- The Breeze and I
- When Yuba Plays the Rumba on the Tuba
- Tumblin' Tumbleweeds
- Sophisticated Sophomore
- Where or When
- The Whistler and His Dog

Paul LaValle, His Woodwinds and Band

RCA CPS-72
Stereo... \$10.95... 23 mins.

I remember Paul LaValle (along with Hank Levine) back in the days of radio broadcasts of the Chamber Music Society of Lower Basin Street. Here LaValle has gathered a band which, backed by amusing arrangements and colorful instrumentation, presents an entertaining recording. The 14 union clarinets make for quite an opener. "Where or When" is the only near-routine, danceable arrangement.

A pleasant tape with high-fidelity reproduction.

PARTY NIGHT AT JOE'S

- Seven Come Eleven
- Southern Fried
- Stompin' at the Savoy
- Bubble Boogie
- Jersey Bounce
- Charleston Alley
- The Major and the Minor
- Five O'Clock Whistle
- Warm Up
- Let's Go Home

Joe Reisman and His Orchestra

RCA CPS-73
Stereo... \$10.95... 27 mins.

Guaranteed to keep the party from going slack, this recording is upbeat all the way. Reisman abandons his usual lush singing strings and strikes out with a big-band and a sharp beat. The recording is spiced with good solo stuff. Walter Levin-sky shows off his clarinet style in "Stompin' at the Savoy" and "Let's Go Home," and doubles on alto sax in "Charleston Alley." Joe Wilder sings out on trumpet in "Bubble Boogie" and "5 O'Clock Whistle." Urbie Green on trombone and Tony Mot-tola at guitar shake things up a bit in "Jersey Bounce" and "Warm Up."

The younger set here likes this one and the fidelity is "right there."

THEY'RE PLAYING OUR SONG

Goodby Blues

- Time On My Hands
- All the Things You Are
- Singin' the Blues
- My Ideal
- Stormy Weather
- Again and Again and Again

Billy Butterfield and His Orchestra

RCA BPS-77
Stereo... \$8.95... 21 mins.

It's been quite awhile since we heard from Butterfield (Bel Canto #501, June '56) and this new tape is welcome. It is predominately a "smoothie" but there are a few uptempo numbers, i.e., "Goodby Blues." The orchestra functions together smoothly. Butterfield trumpets well in "Singin' the Blues" and "Stormy Weather." His wife, Dottie, gives a not-too-ideal vocal of "My Ideal."

The reproduction is fine.

THE LENNY HERMAN QUINTET—PLUS!

- Will You Take a Walk With Me?
- I'll Take You Home Again, Kathleen
- Glowworm
- Ma, He's Making Eyes At Me
- Canadian Capers
- I Found a Lucky Penny
- The World Is Waiting for the Sunrise
- Sleep
- Martha Polka
- Tales of the Vienna Woods

LIVINGSTON #1097-BN
Stereo... \$11.95... 30 mins.

Another of the very enjoyable Lenny Herman Series, offering intriguing arrangements of several old favorites. Here the basic Herman group is augmented by several other fine musicians and vocals supplied by Bill Marine's Girl Trio and the Hermanaires. I personally would have eliminated the "Tales from the Vienna Woods," as this treatment doesn't do much for Mr. Herman or Mr. Strauss! Otherwise, it is very pleasant listening. The stereophonic effect is more natural than in the previous Herman tapes. J. L.

JAZZ

MONK'S MUSIC

- Off Minor
- Epistrophy
- Well, You Needn't
- Ruby My Dear

RIVERSIDE RT 7-20 BN
Stereo... \$11.95... 33 mins.

Thelonius Monk is known for his unusual and startling jazz productivity, both as a pianist and as a composer. On this tape you will hear Monk's own compositions, which might variously be described as erratic, progressive, interesting, complex, etc.

His supporting crew gets plenty of solo work as you will hear. Gigi Gryce on alto sax gives out in "Off Minor" and in the lengthy "Epistrophy" the spotlight is shared

by Coleman Hawkins on tenor sax, Ray Copeland on trumpet, Wilbur Ware flicking the bass, and Art Blakey beating the drums. On loan from Prestige records is John Coltrane, tenor sax. It is not until "Well You Needn't" that Monk's piano gymnastics become highlighted. "Ruby My Dear" does not have as many jerky rhythms and is a bit slower and more saccharine than the other numbers.

The reproduction is very good . . . the music is for progressive jazz fans.

CAUTION! MEN SWINGING

Spring Will Be a Little Late This Year
Shoo-Shoo Baby
Isle of Capri
South of the Border
Three Little Words

Dennis Farnon and His Orchestra

RCA BPS-78
Stereo . . . \$8.95 . . . 17 mins.

We find combined here the imaginative stylings of Canadian-born Dennis Farnon and the last word in modern stereophonic recording techniques; the result is a really sensational jazz tape. Each of these old favorites accommodates nicely to the Farnon treatment which gives ample play to the ad lib solo choruses which showcase the various sections of this talented musical group. If you are a devotee of the "Swing" idiom at its finest, you will love this tape. J. L.

MISCELLANEOUS

BARBER SHOP QUARTET of the Cadet
Glee Club, West Point

Goodbye My Coney Island Babe
Sleep, Kentucky Babe
Beale St. Mama
George Jones

Cadets Harvey Mullins, William Webb,
William Sealey, John McKillop

PHONOTAPES Cameo SC 401
Stereo . . . \$4.98 . . . 9 mins.

Recorded at a "live" performance, the cadets, as well as the audience, seem to enjoy themselves. The fellows sing in lively fashion and evidently do some visual cutting up as there is much laughter interspersed with the singing.

The listing on the back of the box I received is not correct, so I have listed the numbers above. The fidelity is clear.

NOVELTY

SOUNDS OF SPORTS CAR RACES

PHONOTAPES Cameo Series SC 405
Stereo . . . \$4.98 . . . 9½ mins.

This is a small audio snatch of The Annual International Sports Car Grand Prix of Watkins Glen, New York. The sounds of a laughing, jabbering crowd, whizzing cars, and public address an-



totally new

PENTRON high fidelity Tape Recorders

Each of the new Pentron recorders offers performance, simplicity and exclusive features that set it apart from the ordinary. Each Pentron is the finest in its price class, bar none! See and hear . . . then choose the Pentron that suits you best.

BRILLIANT FEATURES exclusively PENTRON

- FINGER FLITE SINGLE ROTARY CONTROL
- ENTIRE LINE AVAILABLE STEREOPHONICALLY (STACKED ONLY)
- BIGGER AMPLIFIERS AND EXTENDED RANGE SPEAKER SYSTEMS
- QUIK-FLIP SPEED CHANGE CONTROL
- MODULAR DESIGN HEAD ASSEMBLY WITH AZMUR-X HEAC ADJUSTMENT
- SEVEN OTHER PENTRON EXCLUSIVES

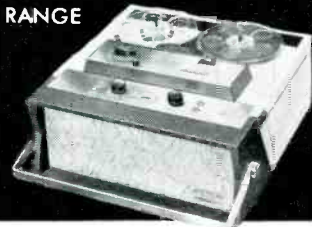

*important
notice!*

Your dealer is now demonstrating new Pentron integrated tape components for custom installation. See them!

"PLAY AS YOU PAY PLAN"

ONLY 10% DOWN
UP TO 24 MONTHS TO PAY

Write for full color literature

PENTRON

784 S. TRIPP AVE.
Chicago 24, Illinois

Canada: Atlas Radio Ltd., Toronto

omega
stereo
puts you in
the center
of the
sound



JOHNNY
MERCER
IN STEREO
PUTS YOU OUT
OF THIS WORLD

Omega tape
HOLLYWOOD



JOHNNY MERCER
SINGS "JUST
FOR FUN"
ST-7019 \$11.95
Johnny sings
Blues in the
Night, Java Jive,
St. Louis Blues,
and 11 others.



\$49.95

Omegatape
STEREO
TREASURE CHEST

THE IDEAL STARTER SET FOR
STEREO-FILES
STEREO TAPES INCLUDED WITH CHEST

ST-50 Paris Dances By Night—Andre Mon-
tero Orchestra \$8.95 • ST-51 Show Hits For
Dancing—Hollywood Radio City Orchestra
\$8.95 • ST-52 Sandauer Plays Pops For
Dancing—Heinz Sandauer Rhythm-makers
\$8.95 • STD-10 Stereo Holiday—12 selec-
tions recorded around the world \$5.95 •
ST-59 Themes From Around The World In
80 Days—Omega Orchestra \$8.95.

The chest is neutral Ash high grain
finished and has space for twenty
7-inch reels. It protects them from
dust and direct sunlight.

ASK FOR
OP-1

AVAILABLE AT YOUR
Omegatape
DEALER

nouncer are all to be found on this short
tape. Frankly, for those who like their car
sounds in small doses, this tape should
suffice. For those who wish to indulge in
a down-to-track, longer intake, then I
recommend Omega's ST 2010 "Clear the
Grid." (Sept. '57) Take your choice . . .
the latter is for the Marlboro-type man.

SEASONAL

A MERRY WURLITZER CHRISTMAS

Sleigh Ride
White Christmas
Winter Wonderland
Jingle Bells
Parade of the Wooden Soldiers

Dick Leibert playing the Mighty Wurlitzer
pipe organ of the Byrd Theatre in Rich-
mond, Virginia

SONOTAPE SWB 7015

Stereo . . . \$6.95 . . . 15 mins.

He's back again, the virtuoso of the
organ, Dick Leibert, this time playing the
fabulous Byrd Theatre Wurlitzer. And as
usual, he plays it magnificently.

While this tape accents the newer Ameri-
can Christmas songs, there are still a few
of the old favorites included.

Talk about surrounding sound—when
Mr. Leibert combines his talent with the
voice of the Mighty Wurlitzer in the Byrd
Theatre, you are there partner, you are
really there.

Top fidelity.

J. C.

CHRISTMAS HYMNS AND CAROLS

O Come, All Ye Faithful
The First Nowell
O Little Town of Bethlehem
O Come, O Come, Emanuel
Away in a Manger
Silent Night
Joy to the World
It Came Upon the Midnight Clear
Angels We Have Heard on High
Christmas Hymn
Lo, How a Rose E'er Blooming
Hark! the Herald Angels Sing

Robert Shaw Conducts
The Robert Shaw Chorale

RCA CCS-86

Stereo . . . \$10.95 . . . 25 mins.

Don't miss having this tape on hand for
the Xmas season. These traditional and
much loved songs are beautifully arranged
and presented with the chorale's usual
finesse. The singing is a capella. The re-
production is that of a big hall or church
and the fidelity is excellent.

J. C.

CHRISTMAS EVE IN THE CATHEDRAL

Adestes Fideles
Collegium Musicum directed by Homer
F. Edwards, Jr.; Frances Shaffer Ed-
wards, organ; Bells; Angelus
Angels from the Realms of Glory Bells
When Blossoms Flowered 'Mid the Snows
Haskell Boyter, baritone; St. Cecilia

Children's Choir directed by Sister
Mary Barbara; Frances Shaffer Ed-
wards, organ; Bells

O Come Emmanuel
St. Gregory Men's Choir (a cappella)
directed by Frances Shaffer Edwards
O Dear Little Children
St. Cecilia Children's Choir directed by
Sister Mary Barbara; Frances Shaffer
Edwards, organ
What Child Is This? (Greensleeves)
Haskell Boyster, baritone
Hark! The Herald Angels Sing
Frances Shaffer Edwards, organ; Angelus

SONOTAPE SWB 7014

Stereo . . . \$6.95 . . . 13 mins.

The best word to describe this tape is
inspirational. It was recorded at the Shrine
of the Immaculate Conception, the Mother
Church of Atlanta, Georgia. This church
was completely renovated and rededicated
as a shrine in 1954. During the renova-
tions, the beautiful old organ was also
repaired. It was decided to split the ranks
of organ pipes, so that the sound of the
organ would encircle the voices of the
choir, and encircle it does. This recording
would be fine for playing in church during
the holidays.

Good fidelity.

J. C.

CHRISTMAS AT RADIO CITY

We Three Kings of Orient Are
O Tannenbaum
O Sanctissima
Deck the Halls
Fairest Lord Jesus
What Child Is This?
Good King Wenceslas
O Holy Night
Silent Night, Holy Night
Joy to the World

Dick Leibert, Organ

SONOTAPE SWB 8008

Stereo . . . \$11.95 . . . 27 mins.

One of the main attractions of the holi-
day season in the great city of New York is
Radio City at Christmas. To bring you the
brilliant scene at Rockefeller Center, West-
minster presents Dick Leibert, playing
favorite Christmas music. Close your eyes
and picture the huge tree with hundreds
of lights, the decorations around the pavil-
ion, thronging crowds of shoppers and
sight-seers, and listen to the specially pro-
grammed Christmas music floating out over
all.

Good fidelity on this one, with selections
artfully rendered by Dick Leibert, as only
he can play them.

J. C.

**HAVE FUN AT YOUR
NEXT PARTY**

Tape record this old fashioned melo-
drama and play it back. Good for a hun-
dred laughs. Five parts, three male, two
female . . . and a donkey. Full directions
for sound effects. Complete set of scripts
(six copies) as presented on air—only \$2.95
postpaid.

HI-FI TAPE RECORDING
Severna Park, Md.

NEW PRODUCTS

NEW SCOTCH TAPE

Minnesota Mining and Manufacturing Co. has announced a new "double play" tape made from durable polyester film which has been "tensilized" by a new process which doubles the strength of conventional polyester film. This "Scotch" No. 200 tape can be used on any tape recorder without the danger of stretching or breaking and without the especially careful handling commonly associated with other double play tapes. It will withstand a pull of 3.6 pounds before stretching, as compared to 1.8 pounds for other double play tapes. The 1/4 inch tape comes in two reel sizes, 7 inch which retails for \$11.95, and 10 1/2 inch which retails for \$26.90. For additional information, write to Dept. M7-369, of M.M. & M. Co., St. Paul, Minn.

SERIES 60 RECORDER

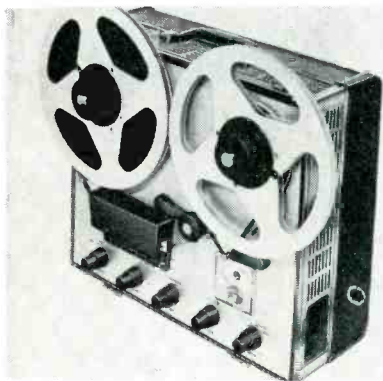

American Electronics, Inc., 655 W. Washington Blvd., Los Angeles 15, Calif., has introduced their Series 60 tape recorders. Model 61 is a half track record and half track playback unit, priced at \$495. Model 62 is half track record with half-track, full track and stereo playback, priced at \$595. Model 63 is a stereo unit, priced at \$695. In all models, the recorder with case is extra. Tape speeds are 7 1/2 and 15 ips; frequency response is from 30 to 15,000 cps, plus or minus 2 db; signal to noise ratio is 55 db at 15 ips, single track; flutter and wow is 0.15% RMS at 15 ips; contains one hysteresis synchronous capstan drive motor, and two high resistance rotor induction rewind and take-up motors; and takes a reel size up to and including 10 1/2". For further information, contact manufacturer.



FilMagic PYLON
(PAT. PENDING)
AUTOMATIC
SILICONE LUBRICATION
CLEAN AND
LUBRICATE YOUR TAPES AND FILMS
WHILE THEY PLAY!

Guaranteed Better, Cleaner, Cooler Reproduction on any equipment. Complete PYLON KIT (specify suction-cup or permanent sponge-type mounting) with re-loader bottle and six FilMagic Cloth Sleeves \$2.95 from your dealer or

THE DISTRIBUTOR'S GROUP, Inc.
204 - 14th St., N.W. ATLANTA 13, GA.

**Record Anything, Anywhere
with "The Magnemite"**

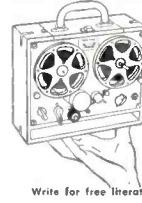

Battery-operated, spring-motor tape recorder designed for professional field use. Assures complete independence from AC power. Meets National Association of Radio and Television Broadcasters standards. 60 Models available.

Write for free literature and direct factory prices to Dept. TR.

AMPLIFIER CORP. of AMERICA
398 Broadway • New York 13, N. Y.

CONVERT YOUR TAPE RECORDER INTO A CONTINUOUS MESSAGE REPEATER

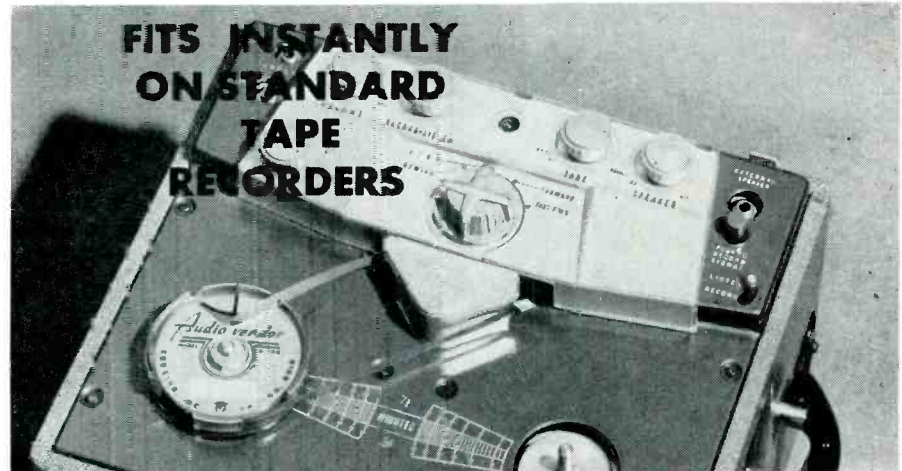

**FITS INSTANTLY
ON STANDARD
TAPE
RECORDERS**

AUDIO VENDOR

MODEL U-300-C or U-300-CC
Loaded with 180 ft. Cousino
Friction-Free Tape
\$12.50 Postpaid
Satisfaction Guaranteed

The AUDIO VENDOR will convert your tape recorder into a continuously repeating mechanism. Successfully used to teach, sell, announce, dictate and for sleep learning. Plays from 5 to 10 minutes. Double time with a MOBIUS LOOP. No rewinding necessary. Repeats message or music continuously hour after hour. Send for literature on our longer playing models and accessories. Advise make and model of your recorder.



FRICTION FREE TAPE — No. 109

300 foot reel	6.66
500 foot reel	13.32
1200 foot reel	26.64

**TAPE SPLICER KIT
AT ONLY \$1.50 LIST**

If not available at your dealer, order from

COUSINO INC.

2109 ASHLAND AVE., TOLEDO 2, OHIO

CANADIAN DISTRIBUTOR: Dominion Sound Equip. Ltd., 4040 St. Catherine St., W., Montreal 6, Quebec

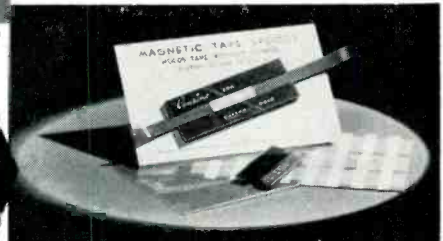

"BEAT THE HORSES"
(A Tape-Recorded Parlor Game)

More fun than the hayburners themselves! Eight races on tape complete with sound effects, odds, cues and full instructions. Have fun!

7.5 Ips, \$2.95 — 3.75 Ips, \$1.95
Free Catalog. "Sampler", 99c
HOUSE of STONE • Lunenburg 5, Mass.

PLASTI-TAK

The amazing plastic adhesive material with many practical and proven tape recording uses. Anchors tape ends. Removes glaze from felt pads and stops squeaks. Removes finger-marks from tape and aids in splicing. Lots of other uses. Send \$1 now for yours, postpaid.

BROOKS MFG. CO. Dept. 81, 1514 Aster Place
Cincinnati 24, Ohio

TAPE DUPLICATION

Finest work done on Ampex Hi-Speed Duplicators—No order too small or too large—1 tape or 1000. Write today for descriptive brochure and prices.

SAMUEL CANDLER ENTERPRISES
P. O. Box 9667, Atlanta 19, Georgia

INTRODUCTORY OFFER

7" Reel with
LOCKLIN TAPE ANCHOR therein.
\$1 Postpaid.

SATISFACTION OR MONEY BACK.
LOCKLIN-TAPE CLIP CO.
1036 Monterey Blvd. St. Petersburg, Fla.

AMPEX STEREO

SIGNATURE OF PERFECTION IN SOUND

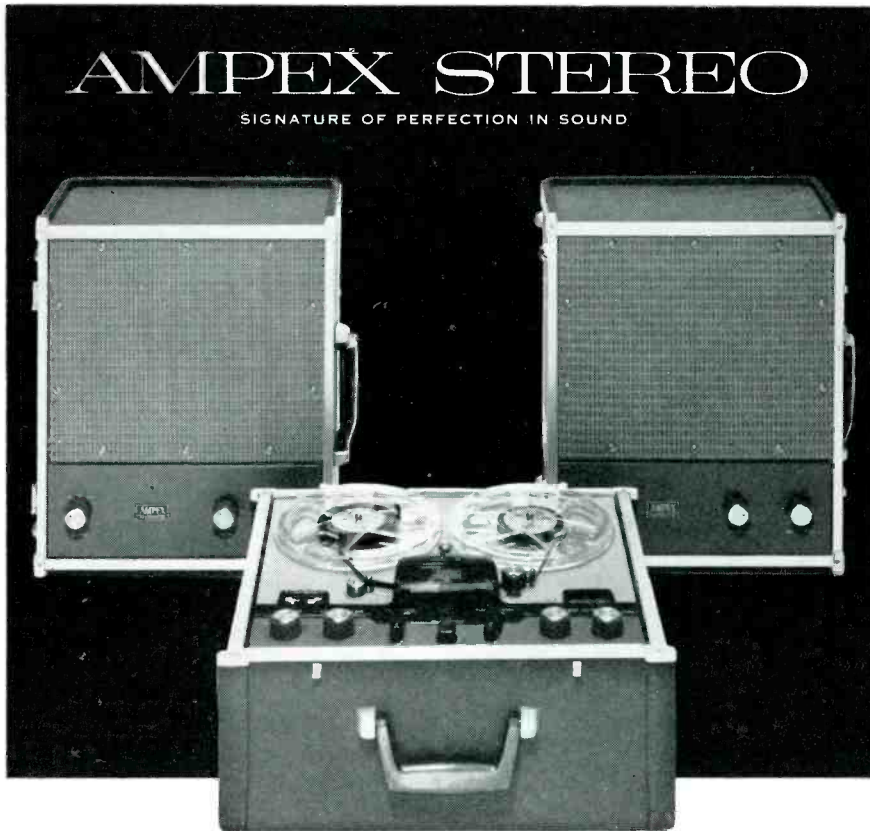

An audio system is like a chain. For optimum performance, all the links must be equally strong... there can be no compromise with "weak-link" components in the system.

It was on this premise that the Ampex A122-SP Portable Stereophonic System was designed. Each link in the chain—from recording and playback heads to speaker—was forged to the same exacting standards and precision tolerances which guide the manufacture of world-famous Ampex professional recording and playback equipment.

Heads—Facing surfaces of head gaps lapped to an optical flatness so precise they reflect a single light band (1/3 micron) on flatness gage. This, plus initial surface polish of 6-8 micro-inches, insures sustained frequency response with negligible change in characteristics over many thousands of hours of operation—many times longer than with ordinary heads.

Amplifier-Speakers—Ampex-designed, Ampex-built as an integral part of system... yet may be used separately with other units of your system (has front-panel input switching for Tape, Tuner, TV, or Phono). Amplifier sensitivity 0.25 v for maximum power output; 20-20,000 cps \pm 1/2 db output with well under 1% harmonic distortion. Speaker features unusually high total gap energy, converts a maximum of output power into sound energy, with smooth, peak-free response.

Complete Specifications—Write today for free new full-color brochure containing complete specification sheet and description of full line of unmounted units, consoles, modular table-tops and portables.

AMPEX AUDIO, INC.

1034 KIFER ROAD,
SUNNYVALE, CALIFORNIA
Please send free color brochure to:

NAME _____
ADDRESS _____
CITY _____

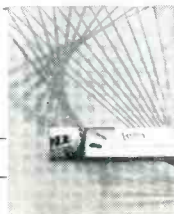

BOGEN TUNER

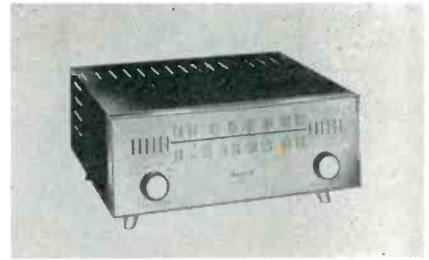

David Bogen Company, Inc., 29 Ninth Ave., New York 14, N.Y., is now offering an FM/AM tuner, Model R620, which features simple, accurate tuning for the full length of both the FM and AM bands by the effective Bogen automatic frequency control circuit with fly-wheel drive and lighted dial pointer. Since the tuner incorporates a built-in cord antenna for FM and a "high-Q" ferrite loopstick for AM, many installations will require no additional outdoor antenna. If an external FM antenna is desired, the R620 affords inputs for either a 300-ohm balanced or a 70-ohm unbalanced line. Also included in the FM circuit are a triode r.f. amplifier and triode mixer for minimum noise, a balanced ratio detector, and an automatic volume control circuit which prevents overloading under strong signal conditions. Price is \$84.50 in the East. Contact Bogen for further details.

TERADO CONVERTER



Terado Company, 1068 Raymond Ave., St. Paul 14, Minnesota, is marketing the "Supreme" and "TV Special Chief" models of Trav-Electric mobile power converters, which convert storage battery current in car, truck or boat to 110 volt A.C. 60 cycle current. The "Supreme" model has a constant output capacity of 175 to 200 watts. It is equipped with a fan-cooled vibrator. It is easily installed with a convenient remote control with switch, signal light and plug-in outlet mounted just under the dash within easy reach. If the "TV Special Chief" is mounted under the dash, remote control is not necessary. It has its own plug-in receptacle.

THE AD WAS RED—WE WERE BLUE

Last month Minnesota Mining and Manufacturing Company, used a double page spread in Hi-Fi Tape Recording to bring the news about their new Tensitized double play tape that is twice as strong as ordinary tapes with the same playing time, and is stretch resistant. The very last line of the two page advertisement read—"Look for it in its new, bright blue carton."

So guess what color of ink the box was printed in—that's right—red... we pulled a boo-boo. So when you go to buy a reel remember the carton is *blue*... red is what our faces are.

TAPE IN EDUCATION

BY JOHN J. GRADY, JR.

AFTER the completion of last month's article relative to the use of tape recording in the schools of Hawaii, additional information arrived from Honolulu which deserves supplementary consideration. This information—really about the lack of information—is of such a nature that it could be of value to educators, especially in those states where Audio has not been developed to such a degree that there is a centralized source where guidance and instruction in the use of audio material and equipment is available for teachers in the schools of the state.

In the public schools of Hawaii, teachers, principals and administrators are aware of the fact that Audio, especially tape recording, is utilized only in a limited elementary way. Some instructors, suspicious of mechanical aids and tools, or a bit fearful of their ability to master the operation of them, have a silent opposition to a change from old methods to the efficient instructional routines of the present day. Maybe, that's a natural inhibition, for way back in the early days of American education, history records that there even was opposition to the use of blackboards. In fact, it took the persuasive eloquence of Horace Mann to convince many teachers and many members of school boards, that chalkboards—considered the first visual aid to teaching—would prove a benefit rather than a distracting invader of classrooms and a usurper of the prerogatives of teachers.

As elsewhere, the ambitious dedicated teachers and administrators of Hawaii regard Audio-Visual instruction with favor. But there are two powerful deterrents to the approval and adoption of magnetic taping as a fully established method for the teaching of certain subjects most adaptable to tape recording. A vigilant, aggressive, well-informed Parent-Teacher Association could wield the influence which would eliminate the two deterrents. Gatherings to foster sociability can't get results. But if the PTA would resort to a practice best described by the inelegant term, NEEDLING, the right kind of action is certain to follow.

The principal reason for the existence of the first of the deterrents, is neglect. TAPE IN EDUCATION will not risk pinpointing the sources of neglect. But neglect is responsible for the fact that there is not sufficient information in Honolulu about the application of tape recording to modern education. This is true despite the existence of a wealth of information which is available through schools that have made exhaustive experiments. And it's the lack of this available information which is to blame for the merely elementary usage of magnetic recording in the public schools of Hawaii. With PTA officials insisting upon factual information fully describing

tape recording installations in mainland schools, the parents of school children—the thoughtful ones—will be in a position to eliminate the number one deterrent to an installation of a fully tested teaching practice in the schools of Hawaii. Such an installation would better prepare students to qualify for success in the highly competitive life of today. For knowledge of the best methods of education is a vital ingredient in assuring the success and happiness of our children. The development, alone, of more articulate students would be a satisfying objective for school administrators. And one result that can be accomplished, via tape recording, is proficiency in speech and languages.

With the first deterrent eliminated, by an adequate knowledge of the application of tape recording to education, the elimination of the second deterrent would be a natural consequence. Any school board controlling purse strings will not refuse the installation of demonstrated better methods, especially those requiring but a nominal investment of school funds in valuable equipment. A quick mental inventory of the equipment in use in various school departments provides a number of precedents assuring that a fully-informed Board will take pride in supplying facilities that will reflect credit on the Board for recognizing measures and installations certain to improve the quality of the training in the schools over which there is responsibility for a better and broader education. Therefore, parents in association with teachers who are active in PTA objectives, in the prosperous Hawaiian islands, are best equipped to initiate advances in the use of Audio equipment by the Department of Public Instruction.

The University of Hawaii has a wonderful opportunity to become a leader in the development of teachers capable of operating the most modern of Audio devices. Summer classes, with competent instructors—perhaps, drafted from mainland colleges—could become extremely popular. The challenge exists, and the need, also. And if the island schools are to keep step with the progressive schools of the mainland, the very first necessary step is the provision of complete information about the latest proven advantages of Audio instruction in the classrooms. Such information will help to equip teachers with a valuable form of knowledge, a knowledge that will expand their versatility, their prestige, and the value of their professional services. The information, too, will prompt parents to supply tape recorders to studious children.

(Quiz to experts in collegiate Audio instruction—How'd you like to spend a couple of months on a beautiful tropical island? Teaching, of course. On a campus with a huge sausage tree.)

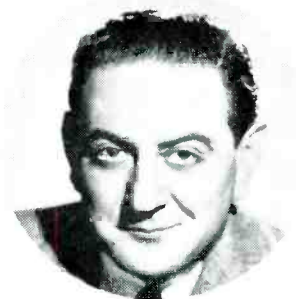

GUY LOMBARDO
makes his tape
recordings on



**That's not
the reason why
you should use**



**Here's why
you should use**



It's the best-engineered tape in the world... gives you better highs... better lows... better sound all around! Saves your tape recorder, too—because the **IRISH FERRO-SHEEN** process results in smoother tape... tape that can't sand down your magnetic heads or shed oxide powder into your machine. Price? Same as ordinary tape!



Available wherever quality tape is sold.
ORRadio Industries, Inc., Opelika, Alabama
Export: Morhan Exporting Corp., New York, N. Y.
Canada: Atlas Radio Corp., Ltd., Toronto, Ontario

Better Results With
ROBINS' AUDIO ACCESSORIES!



GIBSON GIRL® TAPE SPLICERS		
1. Semi-Pro	SP-4	\$ 3.50
2. Junior	TS-4JR	6.50
3. Standard	TS-4STD	8.50
4. De luxe	TS-4DLX	11.50
5. Industrial (5 sizes to 1")	(net)	55.00

ROBINS PHONO AND TAPE ACCESSORIES		
6. Splicing tape	ST-500	\$.39
7. Jockey Cloth for Tapes	JCT-2	1.00
8. Tape Threader	TT-1	.98
9. AUD-O-FILE	AF-50 (net)	23.99
10. Changer Covers	CC-1, 2	2.00
11. Turntable Covers	CC-3	2.50
12. DisClosures	E10, 12 (pkg)	1.20
13. Jockey Cloth for Records	JC-1	1.00
14. KleeNeedLE	NB-1	1.50
15. Phono-Cushion, 10", 12"	PC-10, 12	1.50
16. Atomic Jewel	SE-90	5.00

At Dealers Everywhere



ROBINS INDUSTRIES CORP.
BAYSIDE 61, NEW YORK

QUESTIONS & ANSWERS

Questions for this department may be sent on tape or by means of a postcard or letter. Please address your queries to, "Questions and Answers," Hi-Fi TAPE RECORDING, Severna Park, Maryland. The most interesting and widely applicable questions will be used in this department and all inquiries will receive a tape or letter reply.

Q—I read in another magazine the other day that recorded tapes should always be stored in an upright position, "never flat." Please, is there any sound reason for this judgment? I have hundreds of recorded tapes and have stored most of them flat because, for me, this is much more convenient than the other way. Will you kindly inform me of the validity of the above mentioned opinion. To my mind (with no scientific basis for an opinion) it could matter little either way.—M. G. B., Dixon, Missouri.

A—We can find no basis in the literature for making mandatory the stacking of reels on edge. The only danger from stacking them flat is if many reels are stored one on top the other, the combined weight may distort the plastic reels or damage the edges of the tape. Far more important are such factors as temperature and humidity (best is 70° F, 40-60% humidity) and avoiding excessive winding tension. While the tension per layer may not be great, a thousand layers, each adding a minute bit of stress can add up to tremendous pressure on the tape nearest the hub. An even wind at moderate tension is desirable. Occasional use of the tape improves the storage characteristics. Playing the tape on the machine releases strain and adhesions.

Q—In the article "Custom Build with Stereo Components" in your October issue you suggest "If you presently own a hi-fi rig, you can add an external speaker to your present one." I own now a record changer, an amplifier and a speaker system. I intend to buy now a recorder with stereo playback.

My question is: using my present outfit as one side, would the speakers in the tape recorder serve properly as the second side of the stereo? Or would you recommend the use of an external speaker for the second side, which would be similar to the system I already have?—D. J. H., Camden, N. J.

A—The speakers in the tape recorder will make an adequate second side to your present system. However, a speaker similar to the one you already have and connected to the external speaker jack on your recorder will improve your results. The necessarily small speakers found in many recorders cannot give the same results as a regular speaker system.

Q—This concept of High Fidelity is something new to me. I have read catalogs and specifications until I'm blue in the face. At the present time I am still gathering information and material just trying

to decide just what component parts I am going to buy and match together. I've gotten to a point where I don't know anymore what is good and what is poor. Then to top this off comes stereophonic sound for tape recorders.

I have always thought of including tape in my hi-fi setup but I was going to wait until something worthwhile came along. Well it finally has, but much to my surprise, the terminology has me all balled up again and what are the necessary components to make stereophonic sound work?

As I said before, reading catalogs hasn't done me any good. When I put my set together I want to do it just once and with the best material my wallet will permit.

Now, after relating to you my troubles I wonder if your office could recommend to me some publications that will give me a talking knowledge of hi-fi with a glossary of terms used and one that will include a section on tape recorders, explaining the difference between monaural, double, stereophonic and whatever else there is.—T. A., Brooklyn, N. Y.

A—With the flood of new products appearing on the market, we can well understand how you feel. As to publications, we would suggest Harold Weiler's "High Fidelity Simplified," which sells for \$2.50, C. G. Westcott's "Tape Recorders and How They Work" at \$2.75 and "Tape Recorders and Tape Recording" by Weiler, which sells for \$2.95. Our book department can supply any or all of these books.

Regarding an understanding of hi-fi, just picture the various elements: 1—the sound source, this can be a microphone, a tape reproducer or a record machine, 2—a pre-amplifier which takes the small currents produced by the sound source and amplifies them so that 3—a power amplifier can boost the currents to sufficient strength to operate 4—the loudspeaker.

Hi-Fi is one-eared sound because it is played from a single source, be it disc or tape. Stereo, or two-eared sound, is played from two sound sources. The word two is the key. The sound is picked up by two microphones, recorded on two tracks on the tape, played back through two heads. The currents from the two heads are fed into two preamplifiers thence to two power amplifiers and two loudspeakers, recreating the original sound with utter realism.

STEREOPHONIC TAPES

SAVE TIME & MONEY
All Brands over 300 Titles.

1200 ft. Plastic Recording Tape \$1.59
Write for complete catalog & prices
We mail everywhere.

Hi-Fidelity Electronic Sound Corp.
368 Montgomery Ave., Merlon Station, Penna.

omega
stereo
puts you in
the center
of the
sound



AROUND THE
WORLD IN 80 DAYS
IN STEREO PUTS
YOU OUT OF
THIS WORLD

Omegatape
HOLLYWOOD



ST-59 \$8.95
The OMEGA
ORCHESTRA plays
themes from the
film. (Complete
score available on
ST-3012 \$14.95)

TAPES TO THE EDITOR

When sending tapes to the editor please use the 3" reel and indicate the speed at which it was recorded and whether it is dual or single track. We will listen to your tape, make notes from it for use in this column and then reply on your tape. Please keep tapes reasonably brief.

If you do not own a recorder, a letter will be acceptable. Address tapes or letters to: The Editor, Hi-Fi TAPE RECORDING, Severna Park, Md.

To the Editor:

As you may or may not be aware, some companies have been "souping up" monaural recordings and selling them as stereo. In one instance the maker turned up the highs and reduced the bass to nothing on one channel and then, on the opposite channel the bass is boosted and the highs are chopped off completely. Any actual stereo tape has a normal range of highs and lows on both channels, not just one. I have an Ampex 350-2 with two McIntosh 60 watt amplifiers and I've played and discussed this very same tape with over seven stereo fans—all of whom have recorded stereo at one time or another and it was our unanimous opinion that this tape was a monaural recording. How come your reviewer did not spot it?

Should stereo be mixed? Some stereo recordists, presumably called purists, insist that just two microphones is all that is necessary for recording any kind of music stereophonically and that if in the actual performance, one couldn't hear some instrument, then on the recording there is no point in using a mixer and more than two mikes and "bringing in" the weaker instrument. Quite possibly there's something to be said for both schools of thought (I personally prefer mixed stereo 100%) but I think a discussion of it in TR would be of interest.

Another point worthy of discussion is the stereo technique used in voice recording. A commercially recorded tape of a featured vocalist is recorded two ways at present, presumably because no one has arrived at a standard yet. For example, the Nat King Cole, Capitol stereo tape has Cole's voice coming through both channels with equal volume. On the other hand, Verve's stereo recording of Ella Fitzgerald has the voice coming from one channel. As to which is best, the most accurate and most likely to become the standard might be worthy of discussion.

Again, many thanks for a good magazine. Hope you see fit to expose the sheep in wolf's clothing—the monaural recordings that are palmed off as stereo. If the first few companies that have tried this get away with it, more will follow suit and a downgrading of the whole stereo tape business can't help but follow.—Wally Heider, Sheridan, Oregon.

We will certainly spot a fake recording if we can but, as you know, this is not always easy to detect. We are planning to publish an article in the near future on how stereo faking is accomplished and how it can be spotted in the finished product. Armed with this knowledge, the buyer of

stereo tapes can quickly put the cheating firms out of business by not buying such tapes. Any tape which we suspect of being a "souped up" monaural tape will be very carefully checked.

Regarding standards for stereo recording, we do not believe that they will ever be established, and for this reason: the object of the recording is to present a reel of entertainment. The director of the recording session, now that stereo is available, has in his hands another tool with which he can work to present a more ear tickling tape. He can use the new found ability to get more motion in music, if he desires or to create novel effects. We doubt that such will not be used.

We rather imagine that on recordings of large groups, such as symphony orchestras and the like, a two microphone technique will be more or less of a standard but on the smaller orchestras, etc., it will be up to the recording director. Perhaps the Cole recording was done with two mikes and, when the tape is played his voice would seem to come from the middle rather than appear on two separate speakers as two points of sound.

To the Editor:

Why Stereo? My understanding of stereo is that with it you have what amounts to a first row seat at a concert while with monaural you are sitting back perhaps ten rows (still \$5.50 seats).

I can appreciate the novelty effects possible with racing cars or locomotives running across my living room (I wouldn't mind that once or twice) but why is stereo used for single sources such as an electric organ or vocal soloists.

The organ tape referred to above costs \$6.95 monaural, \$12.95 stereo—tell me, what do I get for the extra \$6.00 aside from \$1.10 worth of extra tape?

Also, can a person get that much difference in enjoyment of music by moving nine rows closer to the orchestra?—Ralph Baschal, Detroit, Mich.

Stereo sound is two-eared sound—one channel for each ear and it recreates the full spaciousness and gives a presence that cannot be matched in any other way. It is not a question of how near or far you might be from the orchestra—the difference lies in the fact that, for the first time, with stereo sound, each of your ears receives the same sound as it would if you were actually in the concert hall. Stereo has outmoded every hi-fi set because it offers everything that monaural hi-fi has plus the feeling of real, living music. To our way of thinking it is well worth the difference in price.

the Magnificent Ferrograph

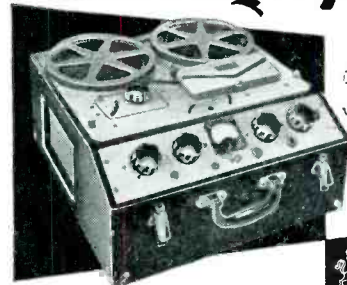

Model 3A/N (portable) with built in speaker. 3 3/4"-7 1/2" ips \$379.50



The world's finest hi-fi tape recorder

The ultimate in high-fidelity tape recorders for home and professional use. Dual-speed, dual-track FERROGRAPH recorders are also available in custom models (tape decks available, from \$195.) and with 7 1/2 and 15 ips speeds. Independent field performance tests rate Frequency Response at ± 2 db between 50 and 10,000 cycles with wow and flutter less than 0.2% at 7 1/2 ips.

Quality standards have restricted our production and unforeseen demand may delay delivery, write TODAY for literature.

ERCONA CORPORATION

(Electronic Division)
551 Fifth Ave., Dept. 31, New York, N. Y.
In Canada: Astral Electric Co. Ltd.,
44 Danforth Rd., Toronto 13

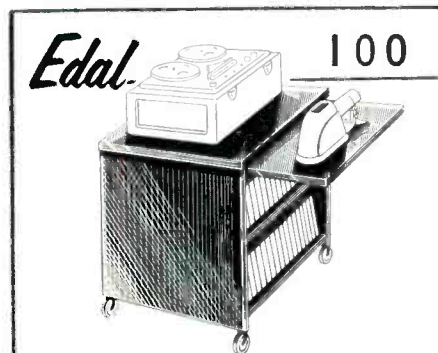

TAPE RECORDER STAND

- Heavy gauge welded steel construction
 - Storage for 92 seven-inch reels of boxed tape
 - Two-way retractable side leaf for slide projector, movie projector or work surface for editing, etc.
 - Special risers encourage air flow over motor and tubes for prolonged operation of recorder without overheating
 - Baked enamel decorator finish to blend with any interior
 - Produced by well-known office furniture manufacturer
 - Conceived and developed by leading industrial designer
 - Shipped to you assembled, and ready to use
- Model 100 A with glider feet.....only \$34.50
Model 100 B with heavy duty casters (as illustrated)only \$39.50
Model 100 I Special institutional model, for schools, churches, hospitals, etc. . . . extra heavy construction with large casters.....only \$49.50
— shipped express collect: —

Edal INDUSTRIES

8015 Forsyth Boulevard
Saint Louis 5, Missouri

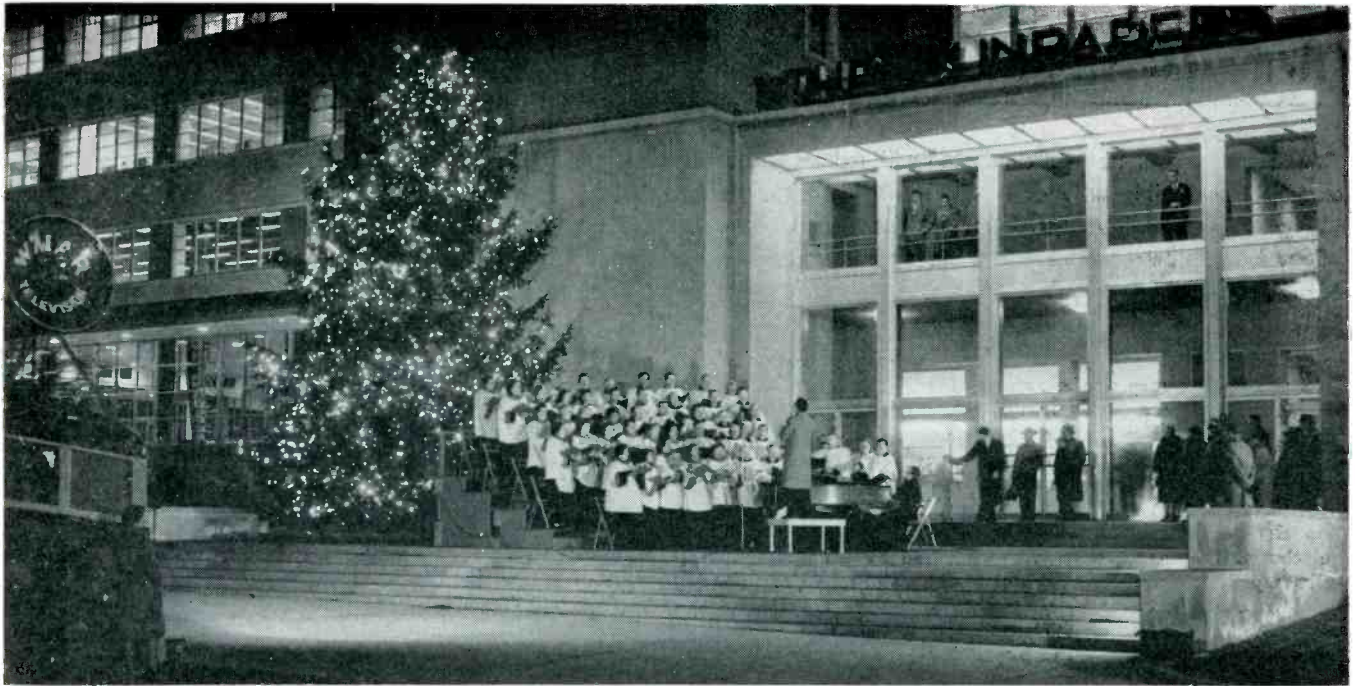

Photo courtesy WMAR-TV

A choral group rendering a program of Christmas carols should be a part of any planned holiday recording. There are a number of such programs scheduled each year by professional groups, as well as by your own church, school, or community. Beforehand planning for equipment positioning and best recording technique is always best when possible.

Tape Your Holidays

by Jean Cover

. . . . Preserve the holiday spirit all year—on tape.

CHRISTMAS

HOLIDAY on tape—that's just what you can have with your recorder, those of you fortunate enough to own one of these versatile machines. And if you belong in the non-owner category, now is the time to casually drop a hint that a recorder would make your Christmas cheerier, and a stereo unit—well, that would make it just about perfect.

Pull up a chair, grab an apple, piece of cake, maybe some peanuts or glass of egg nog, and sit still long enough to jog your thoughts into forming a pattern for a recorded holiday program. For nothing is quite as successful as a well organized procedure.

Your format might begin by recording the discussion with your better half on what to get whom, and catching her ordering the turkey, Christmas cards, gifts, etc. Then, of course, there is the trimming of the tree, from the grumbling over the one branch that doesn't quite look right to the lingering sentimentality over the box of ornaments that have been handed down through the family for generations.

Place the mike close by while packages are being gift-wrapped. You should be able to pick up a tirade of choice comments such as "I don't know why you picked this for Susie, you know she won't appreciate it," or "Boy, you sure threw the money around this year, didn't you pop."

This, together with a few caustic remarks chosen at random over the paper and ribbon that won't seem to do just as you wish, will add a few laughs to your recorded seasonal tape.

And when the scuffle over getting the kids off to bed commences, by all means have the record button and mike ready for action. In fact, your recorder and a taped story might be the answer to the problem of finally getting the little devils to close their eyes and give in to approaching sleep.

Whether your family unwraps gifts at 12 on Dec. 24, after midnight church service, 5 o'clock the next morning, after the fabulous Christmas dinner, or any other particular time, you want to be sure to have the tape recorder handy for the unveiling. Certainly the tape will be brimming over with the happiness recorded thereon. Push the record button when junior commandeers his train, when sis makes her dolly cry, when that teenager gets a few friends under the mistletoe. For this, you might conceal a mike within the ribbons and mistletoe itself. This will provide a good deal of merriment upon playback.

By all means don't forget the recorder when the family sits down to that scrumptious Christmas meal. Capture on tape the saying of grace, the clink of knives and forks against plates, the pouring of liquids, the gay-spirited chatter, passing dishes, fighting over the wishbone—all the little things that love and friendship manufacture, especially at this time of year.

Perhaps you might like to record your Christmas church service, and preserve the sermon that speaks of peace on earth, good will toward men. If so, make arrangements with your clergyman ahead of time to set up your equipment. You will want a mike close to his speaking platform, with the recorder hidden in a nearby room. And don't forget the church choir rendering those lovely Christmas hymns. Before recording this group, it would be well to attend a rehearsal to establish the best mike positioning for obtaining good results.

If there is a special seasonal performance being given by your church group, or your child's school, a drama or perhaps carolling, record it. Make preparations ahead of time for equipment and technique needed for good reproduction. There are a number of special presentations on TV and radio just for the holidays, which are enacted for the public's pleasure. Dramas such as *The Christmas Story*, *Gift of the Magi*, and *A Christmas Carol* are scheduled each year. Why a Christmas tape just wouldn't be complete without a few laments by the wily Scrooge and Tiny Tim's "God bless us, everyone." Watch your TV and radio listings for time and dates, and be prepared to record directly from your set.

While families and friends like to be together during the holidays, this is not always possible. So, gifts and cards are sent out to each other to express, in part at least, the feeling that they wish to convey. There is a way to bring about a greater closeness, a sharing of expression that might otherwise be lost, and that is to also send along a tape recorded greeting. For relatives and close friends, this can be a lengthy, more intimate tape. But for those of you who have many tape recording pals, perhaps in some of

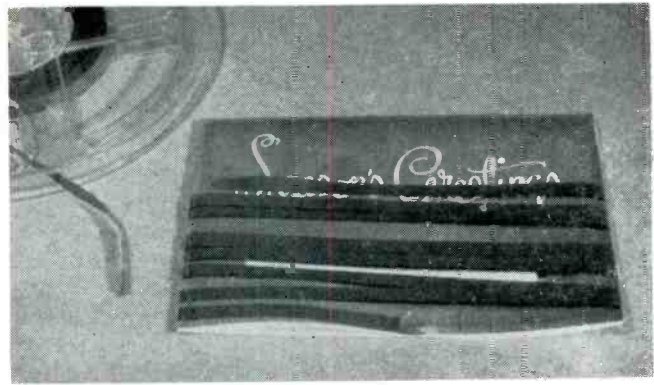

Tape record your Christmas greeting and attach the tape to the card you send. Your recorder-owner friends will be delighted to receive this new idea in season's greetings.

the tape clubs, you could record a 30 second greeting, which would only take from 9 to 10 feet of tape. It would be sufficient time to impart best wishes of the season, and you could attach the tape to a regular card, or maybe even a specially designed card of your own creation. Red and green colored tapes are available, which would fit in with the Christmas color scheme. Those of you in clubs might even organize a season's greeting round robin tape, whereby each would end up with a tape of many greetings, from fellow tape enthusiasts, perhaps some even in foreign countries. What a wonderful treasure to keep.

And those of you who may be separated even more, a kin or friend overseas for instance, if there is some way to exchange recorded tapes, what better token of remembrance is there than to hear each other's voice on Christmas day.

Remember, this feeling most of us have during the Christmas season dies quickly when the tree comes down and it takes a month to get all the pine needles out of the

Catch those unwary guests or friends under the mistletoe. A slim-type microphone can easily be concealed within a paper bell, and then further camouflaged by the mistletoe itself. Such a recording can provide a great deal of merriment upon playback. Some of the remarks and sounds which the mike picks up will be surprising.





When the clock strikes midnight this New Year's Eve, this modern homemaker is going to let loose with stereo noise outside the front door. The two Ampex speakers pictured here are set up for that purpose, although they are just as effective for playing outdoor seasonal music. It's almost a certainty the neighbors will drop by to inquire about the wonderful stereo sound.

living room, when all the bills roll in, when the offspring scatter the new toys throughout the house, when the complacency of every day living returns for another 364 days. Once on tape, it is never completely lost, but is there at the push of a button.

Here's a really different idea for your Christmas decorating and entertainment plans. We believe most everyone with a recorder will wish to try this. We are referring to a Christmas wreath which conceals a 4" speaker. Just imagine your friends and neighbors walking up to your front door to be greeted by the sound of Christmas carols, or perhaps your own recorded greeting emanating from the wreath hanging there.

All you need is a 4" speaker with an extension line connected to it and a jack. It would be well to use flat twin-lead wire which would fit easily under the door or through a mail-slot. Or, if you prefer, you can entwine crow's feet around the hanging wire to cover it over. Whatever your method, you can be sure your musical wreath will be a big hit.



NEW YEAR'S EVE

"10 - 9 - 8 - 7 - 6 - 5 - 4 - 3 - 2 - 1 - ZOWEEEEEE!" Another satellite launching? A hydrogen bomb explosion? A scientific experiment? A contestant trying for a million dollars? Nope, nothing so mild—

it's 12 midnight, December 31st, and as the hands of the clock totter at the zero hour between a year of memories and a year of expectations, all bedlam breaks loose. Such is the case with millions of people who wonderingly, but hopefully, welcome in the new year.

Events for the coming 365 days are shadowy, especially in these days of scientific wrangling and unexplained happenings, but most folks take a firm step over 58's threshold with the customary ear-shattering accompaniment. Seems like everyone is out to roll his neighbor's ear drums the loudest. Well, hold onto your vibrations fellow greeters, because this year we can give Father Time the boot via tape and stereo. And we can say "hi" to Baby Progress with one of his milestone rattles. For tape recorded stereophonic sound reproduction is truly a milestone in our progressive civilization.

If you're wondering what those two box-like things sitting outside the door on the porch next door are for, you can stop guessing. I'll let the litter of kittens out of the bag and give you a broad, nothing-left-to-chance hint. They're speakers, friend—two speakers for two channels of sound, boisterous, gay, wonderful, new-yearish *stereo* sound.

When this new year is born, those enthusiastic tape recording neighbors of yours are going to push a button and when the tape on their machine

crosses the heads you're going to hear sound like you never heard sound before on New Year's Eve.

There are two particular stereo tapes available which would be just

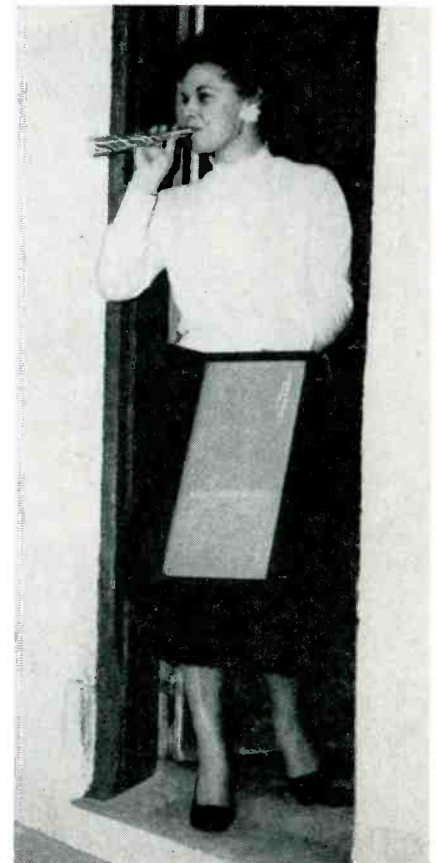

Happy New Year! It's 12 o'clock, Dec. 31, and this gay celebrant leaning out the door holds a speaker, through which there emerges a variety of loud taped noise.



Above: For a different Christmas idea, conceal a 4" speaker within a wreath. Here we are using alligator clips, but soldering would be even better. A jack on the other end of the wire plugged into a recorder, together with a reel of Christmas favorites, or, better still, your own personal recorded greeting, is all you need. Right: During the holidays when friends come to call they will be delightfully welcomed by the sound flowing from the wreath nestling against the door.

the thing to blast off with at midnight. These are the two volumes of Robert Oakes Jordan and James Cunningham's "Sound In The Round" recordings. The first of these recordings contains sounds of trains, airplanes, street-parades and bands, football-games, etc. And among the sounds on the second is a recording made at the Chicago stockyards—unusual and loud. Both of these are released on the Concertapes label.

Again, we urge you to make sure a stereo reproduction system is included in your Christmas purchase plans, if you don't already have one. Treat your own family to this gift-of-gifts, so that when those New Year celebrants sound off the welcoming strains and mad noise, you can join 'em—it's a cinch you can't beat 'em.

Now we are aware, of course, that there are still a majority of folks who have monaural recording equipment. For them, there are loads of sound effects records available to tape, which would be most appropriate for the New Year occasion. Things like air raids, fire engine sirens, boat whistles, dogs and cats fighting, and the like. Then too, you can really have a ball recording your *own* sound effects. This time things like banging on pots and pans, beating a drum, screaming, whirring noise makers, popping bags and balloons, breaking bottles, etc., are on tap. Whatever the racket on the tape consists of, place a speaker outside your home, or hold it out a door or window, turn on full volume and let 'er roll.

To you New Year party givers—a few suggestions. Create two replicas, one of Father Time and one of Baby Tomorrow. Conceal a speaker in each. Sometime during the evening have your guests record on one tape the event or experience which affected them most during 1957, and on another any resolutions they may have for '58. Later, these can be played back through the replicas and those present can try to guess what happened to whom and who resolved what.

Get a small group of folks together sometime before the party. Have them all put on their thinking beanies and dream up a mad list of "Predictions for '58." They can run



the gamut from the ridiculous to the sublime. For instance, some may go like this. "Next year I'll steal my neighbor's wife"; or, "Ladies skirts will be shorter and necklines will plunge"; or, "I'll become a bum and be happy"; or, "Yul Bryner will grow hair"; or, "Burlesque will make a comeback"; or—well, you name it. The possibilities are endless.

Choose the best of the lot and record them, leaving a slight pause between each. At some point during your New Year party, have each guest establish whether or not the prediction about to be played is true or false and then see what pops up on the tape. The results can be hilarious, especially if you plan ahead and pick a certain prediction for a certain guest. Try this party stunt and see if it doesn't liven things up a bit.

Record the group singing Auld Lang Syne. You'll want to keep this recording. And just as a memento of the evening, you could later reproduce the recording for those guests who have their own recording equipment and present them a copy with your compliments.

Party time is the ideal time to record the second track on one of the new Add-The-Melody tapes. These different releases contain only the harmony of songs on one track—you record the melody on the second track, with the result being that you hear yourself or group together with the accompanying harmony upon playback. These tapes are available from Livingston Audio Products Company.

You won't regret taping your holidays, and during the year when you get to feeling a little blue, you might just pull out this tape and play it through. You will find that it will give an added lift to your spirits.

HEARTS



Photo by Nat'l Institutes of Health.

A model of the human heart, with cut-away sections.

ON TAPE

by R. E. Atkinson

... heart sounds on tape are life-saving sounds—fast becoming a tool of the medical profession.



Dr. John K. Hilliard, chief engineer of Altec Lansing Corporation, listens with rapt attention to his heartbeat registered by the heart medical microphone system which he developed for teaching and diagnostic use by medical schools and cardiologists. This system is in use at Johns Hopkins Hospital, Baltimore, Maryland, Georgetown University, Washington, D. C., and other medical schools.

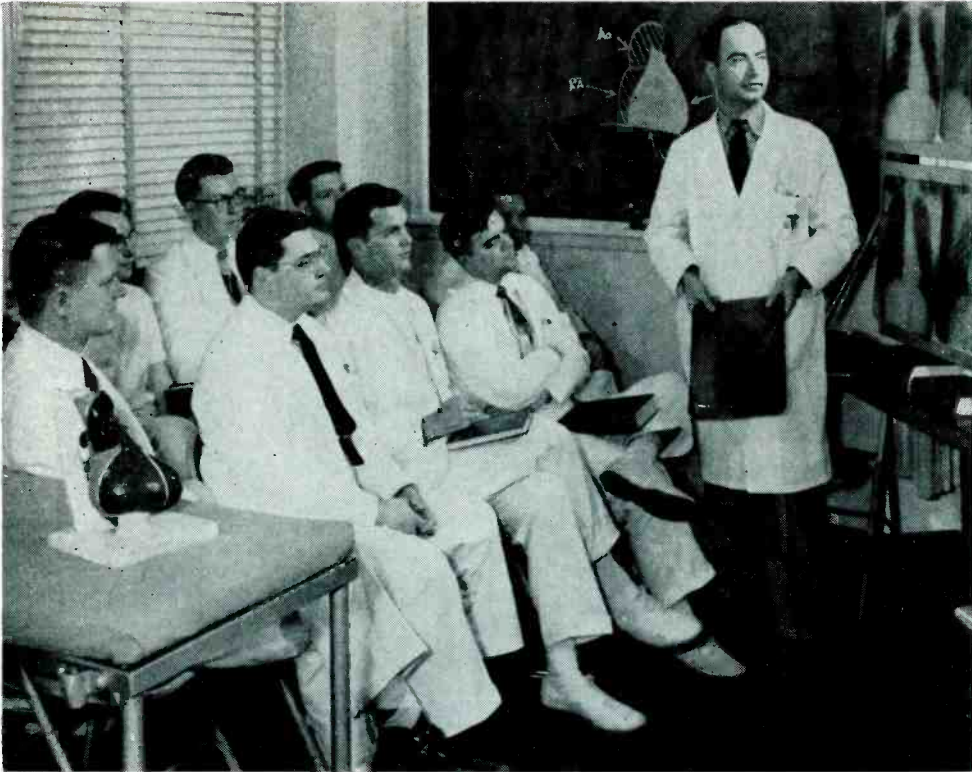

A group of medical students studying heart abnormalities. Tape recordings of heart sounds, used by medical schools, may amplify visual instruction. As the student sees the visual presentation of what causes the heart abnormality, he also listens to a reproduction of the sound of a beating heart, as it would sound if his stethoscope were against the chest of a patient afflicted with this abnormality.

ONE of the features that attracted the public when the new Public Health Service Clinical Center opened in Bethesda, Md., was a tape recording of heart sounds. Interesting to people in general, these heart sounds on tape are vastly more significant to the clinician and researcher.

Recording heart sounds on magnetic tape is a relatively new innovation of medical science. It is undoubtedly going to play an increasingly important life-saving role in the training of young doctors—and in refreshing the memory of older practitioners—in diagnosing various forms of heart disease.

Over three-quarters of a million of our people die of heart disease each year. Because of tape recordings, some of these people will be saved, their lives extended through the benefits of early, accurate diagnoses by physicians with "educated" ears.

When medical students have to learn heart sounds (auscultation) by waiting in turn in groups by some patient's bed, many may have no leisurely opportunity for careful study. Many different kinds of heart patients may not be available. It is not extraordinary for students who must learn by bedside observation to enter medical practice without ever having heard what doctors call "the bruit of a patent ductus arteriosus," a heart abnormality, or the sound of a pericardial friction rub. This has been pointed out by Doctors George D. Geckeler, William Likoff, and Daniel Mason of the Hahnemann Medical College and Hospital in Philadelphia. These doctors are exponents of teaching auscultation by endless loop tape recording.

Another collector of heart sounds on tape is W. Proctor Harvey, M.D., of Georgetown University Medical Center, Washington, D. C. The sample heart sounds played back from tape to visitors at the Clinical Center "open house" made note of Dr. Harvey's work, which has been carried forward, as have the Hahnemann College tapes, with grant support from Public Health Service's National Heart Institute.

Dr. Scott Butterworth, as Chairman of the Committee on Auscultatory Phenomena of the American Heart Association, is another doctor who has been keenly interested in tape recordings.

It is interesting to note what a refinement in technique the modern electronic method represents over practices of only a few generations ago. Joseph Leopold Auenbrugger (1722-1809) made use of sound in relation to heart disease by "chest thumping" (percussion). The son of an Austrian innkeeper, he had at a very early age learned that by thumping a barrel one could by ear determine the quantity of fluid content. Auenbrugger also was an ardent musician, experienced in distinguishing the different qualities of sound. Thus he learned to thump the human chest, seat of the heart, to gain a general idea of the heart's environment.

More specific to the heart, itself, was the listening device of a French physician, Dr. Rene Laennec, who, in 1819, made the first stethoscope to solve the problem, so the story goes, of a modest maiden who insisted he use a remote method of listening to her heart. He created his instrument of several sheets of paper turned to a cone which he placed to his ear.

In 1941, Doctors M. B. Rappaport and H. B. Sprague moved a step closer to heart sounds on tape as they published a scientific paper in the *American Heart Journal* of March '41 outlining "The Physiologic and Physical Laws that Govern Auscultation, and their Clinical Application: Acoustic Stethoscope and Electrical Amplifying Stethoscope and Stethograph." The modern stethoscope now could be electrically adjusted to amplify sound.

When recording of heart sounds is done with a stethoscopic microphone, a record is obtainable of all the vibrations that would reach the ear through the stethoscope, including the low-pitched tones that are not actually heard. By means of any microphone that will respond to low-frequency sounds, heart sounds can be recorded. Demon-



Photo by Nat'l Institutes of Health.

When the \$64 million Public Health Service Clinical Center for patient research opened, visitors at the "open house" gathered about as this Public Health Service doctor demonstrated a heart model, shown on the desk, as tape recordings of heart sounds were played. The sounds on tape attracted a great many people, who might otherwise have passed by.

stration of actual clinical material to supplement tape recordings is possible by using an ordinary cut-in switch and a recording microphone with the edges sealed by ordinary rubber tubing.

It has been demonstrated that it is possible to record practically all heart sounds and murmurs at less than 2,000 cycles per second. Very low cycles also exist.

The tape speed of 15 inches per second, used on some heart sound recordings, may well be no better than recordings made at $7\frac{1}{2}$, since recent improvements in equipment allow excellent results at the lower speed. High fidelity all along the line obviously is most essential in recording and reproducing normal and abnormal heart sounds. The tape transport system, itself, is important, since a variation in speed would be equivalent to a false reproduction.

At Hahnemann Medical College in Philadelphia endless loops of tapes on which heart sounds, murmurs, and arrhythmias have been recorded have been found particularly effective in teaching large groups of students and physicians. Other methods also are in use elsewhere. Hahnemann College since 1950 has been making original reel-to-reel recordings of normal and abnormal sounds in the conventional manner with a dynamic mike and a high fidelity recorder. The recordings are made in sound dampened or acoustically equipped rooms, and the listening students or M.D.'s find they sound quite like what actually will be heard with the stethoscope against the patient's chest.

Tape recorded playbacks of the labored breathing of patients suffering from various chest diseases offer a new aid to doctors in diagnosing other cases also, the United States Public Health Service announced. The new technique was demonstrated by the health service in an exhibit at the 50th anniversary meeting of the National Tuberculosis Association.

As visiting doctors tuned in with stethoscopes, health service demonstrators ran off recordings of breathing sounds described as characteristic of pneumonia, tuberculosis, bronchial asthma and other chest conditions in varying stages of severity. Simultaneously, as each breathing sound was described by a recorded commentary, X-ray visualizations of the patient's chest appeared on a screen. The program for the doctors opened with a tape recorded presentation of normal breathing, as it sounds through a stethoscope. Then followed various abnormal sounds ranging from that of moderately advanced pneumonia, which sounds like wind whistling around a building, to that of bronchial asthma, which has a strange, high-pitched, almost musical quality.

One potential value of the procedure, the service said, lies in providing an opportunity for doctors to have such a permanent recording in their offices, for periodic "refresher" courses in recognizing sounds peculiar to certain conditions. The service also believes this method to be of great value in teaching medical students.

Dr. John K. Hilliard, chief engineer of Altec Lansing

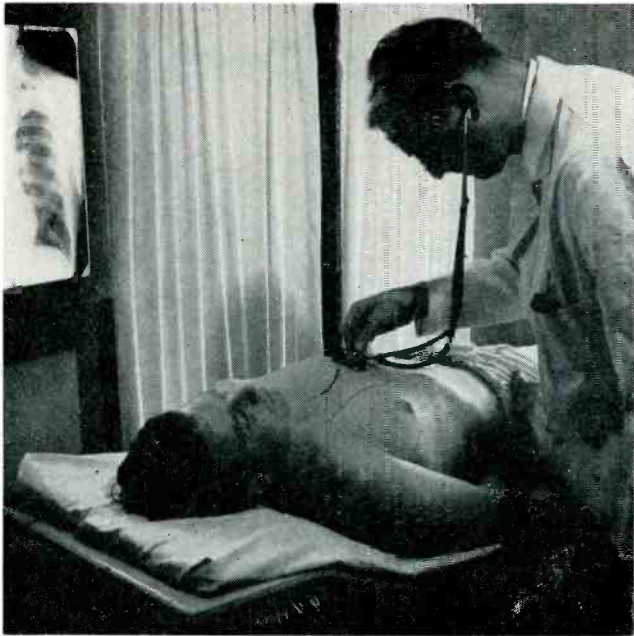

*Photo by National Institutes of Health
Photographic Research Section.*

Left: A heart test with the stethoscope has always been a standard part of physical examinations. Middle: Now, however, thanks to the heart microphone, the doctor is able to record the heartbeat for later and more thorough study. Here a ten year old boy's heartbeat is recorded. Dr. Hilliard, who developed the electronic aid to auscultation to its present degree of efficiency is shown on the right. Below: The Altec Lansing M16 microphone system for cardiovascular studies. It consists of type 21BR-150 microphone, 165A base, P-525A power supply, and 2A microphone attachment. The Rieger Bowles stethoscope shown is obtainable from medical supply dealers.

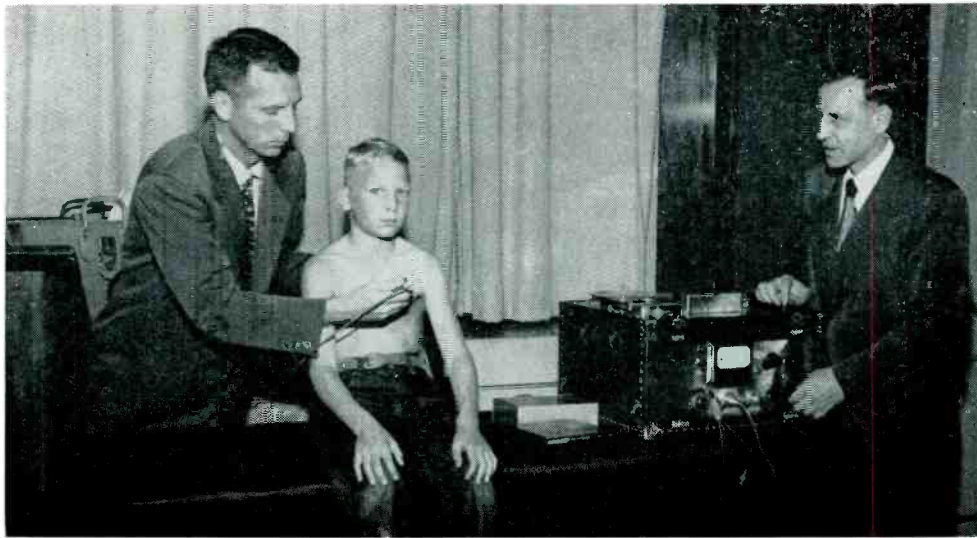
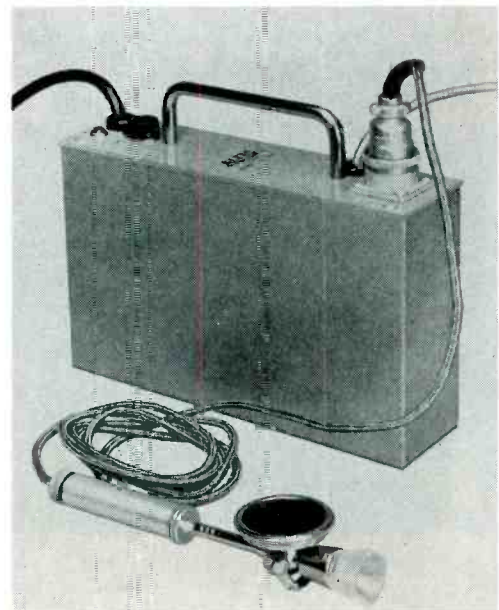

Photo by Rothschild

Corp., has developed an Altec heart medical microphone system, which is of great value for cardiovascular studies. The basic elements of this system are a microphone, stethoscope, power supply and amplifier. With this, heart sounds are recorded on magnetic tape, using high quality recorders. The technique of listening to these recordings consists of having the listener use the clinical stethoscope, holding it approximately 2 feet away from the loudspeaker. This method conveys to the listener a transition between the heart sounds ordinarily heard with the clinical stethoscope as contrasted with the sounds heard with the electronic stethoscope.

The ease with which tapes may be edited facilitates selections of certain groups of sounds. If verbal explanations are desired, these are made at approximately the same volume level as the sounds themselves.

Thus medicine is writing another chapter in the story of the versatility of modern magnetic tape. The doctor's training with heart tapes may help him someday in saving a life through more skilled diagnosis.



Daily Care of Tape Recorders

by Joseph Zelle

Technical Staff, WERE AM-FM-TV

... longer recorder life and better reproduction
are benefits derived from regular cleaning.

IN broadcast and recording studios, where tape recorders are used constantly, a certain routine maintenance of important parts must be kept. In general, this amounts to daily inspection and cleaning of the magnetic heads. Occasionally, the relays, brakes, clutches, and motors may need attention. This latter maintenance, however, may be on a month to month basis.

At WERE, one of America's top independent stations, a great deal of tape recording is done almost every day. Over the week-end many of Bill Randle's and Phil McLean's shows are tape-recorded for many hours. In addition, during the week, most commercial spot recordings are first done on tape. At times as many as a dozen takes may be necessary before a commercial spot is acceptable. This final take is then electrically transcribed onto an acetate disk.

As a consequence of such frequent and prolonged use of tape recorders, it is necessary to keep recorder heads clean. Not only does dust accumulate, but some of the iron-oxide coating from the recording tape wears off. Much of this scum will become deposited in crevices and the corners of the magnetic head. Since iron-oxide is a magnetic material, it will affect the characteristics of the recording and playback heads. In serious cases, such conditions can introduce distortion, stuttering, lack of brilliance, and lowered efficiency.

The actual care need take but a few minutes, and should be assigned preferably to one or two individuals. It thus becomes their daily responsibility to see that the magnetic heads get a good cleaning and wiping at least once a day, during the week days.

At WERE, ordinary smoking pipe cleaners, such as can be bought at cigar counters, are used. These are soft wadded long sticks which absorb cleaning fluid. They also get most of the dust, dirt, and iron-oxide out of the magnetic heads without injuring the mechanism. Pipe-cleaners are by far cleaner and more effective than ordinary cleaning rags, which may be dirty and leave a deposit of lint.

The writer prefers, however, one of the two-ended nylon brushes such as provided by the Schick Shaver. The nylon bristles are always clean and free of lint, and are most effective in digging out and scooping out the deposits in very difficult corners. Some operators frown on these nylon brushes as being too strong and harsh on the mechanism. However, if the heads are kept clean, harsh brushing will be unnecessary. Moreover, only gentle pressure should be used. If the heads are maintained regularly, say every other day, or even once a week, there will not be such a heavy sticky deposit that stringent brushing will be required.

One precaution that should be pointed out, is that the rag, pipe-cleaner, or brush should never be dipped into the cleaner fluid. The cleaning tool will always have some deposit of dirt and will tend to adulterate the whole bottle of cleaning fluid. By far the best practice is to obtain the cleaning fluid in a bottle with an eye-dropper. Then it can be transferred from the bottle to the cleaning tool drop by drop. This provides a constantly pure cleaning fluid. The dropper further controls the amount of cleaning fluid to the recording heads. This is economical in using just enough. There is no waste. Secondly, it avoids soaking the mechanisms with an over supply. Experience will soon show just how much fluid is needed for a particular job.

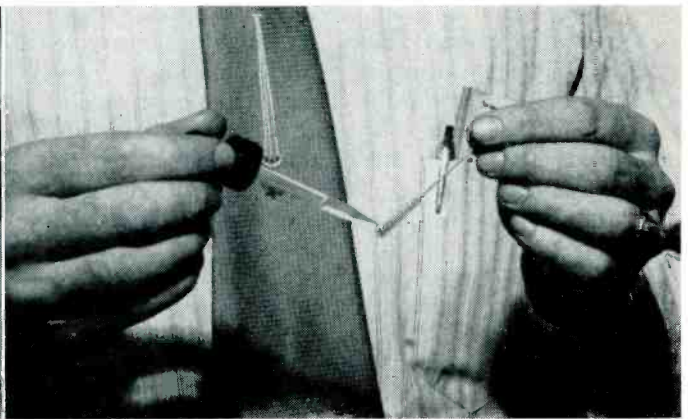

Left: Dipping a brush into a cleaning fluid is quick and easy, but unsanitary and highly undesirable since any deposit of dirt on the brush comes off and mixes with the whole bottle of fluid. Right: This illustrates the correct way to soak the brush with cleaning fluid. Here the use of an eye-dropper is made to transfer the fluid to a small nylon brush.



Left: A clean cloth, on which the cleaning fluid is poured or dropped, is the best method for cleaning rubber rollers. Note the track of grime left by tape. A build-up of this grime on the rollers can cause slipping and faulty tape speed. Right, Top: Tape guides and automatic cutoff should be cleaned regularly. Here we are using Long Life Cleaner, one of the newer cleaning fluids. Right, Bottom: Ordinary pipe cleaners are ideal for cleaning heads. They are absorbent and do not leave any lint behind. A substantial accumulation of dust and iron oxide particles on the heads can cause distortion, stuttering, lack of brilliance, and lowered efficiency.

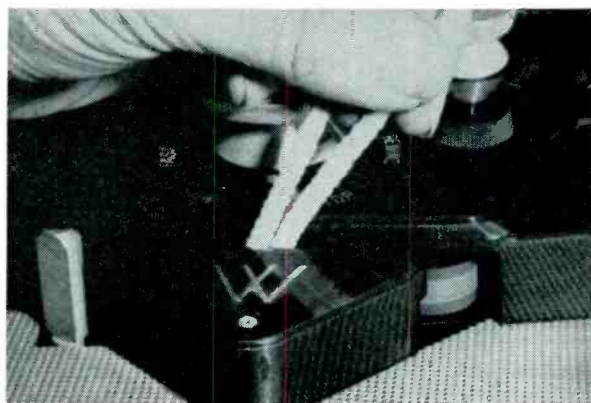

As for fluid, there is some difference of opinion. You take your choice. Carbon tetra-chloride, or Carbona, is one of the old stand-bys. One argument against this cleaning fluid is that it leaves a film after it dries. This film however should not be too objectionable. When used for cleaning the rubber rollers, the argument is that the rubber tends to deteriorate and grow soft. A very important objection and a precaution, is that prolonged use of carbon tetra-chloride is dangerous. Inhalation of the fumes attacks the kidneys which proves fatal in many cases of over-dosage.

Another popular cleaning fluid is pure ethyl alcohol or grain alcohol. In this instance, it is desirable to have the alcohol in pure form, that is, without water in it. Generally, such pure form of alcohol is somewhat difficult to get, even at the best pharmacies. It is a little difficult to keep, too. However, it is well worth the effort, since moisture can have deleterious effects on the magnetic mechanism. By keeping the alcohol bottle always tightly closed, and opened only for short periods to drop the fluid on the brush, it should be effective and safe for relatively long periods.

Cleaning the rubber rollers with grain or ethyl alcohol is also supposed to have a deleterious effect on the rubber.

On the other hand, the rubber rollers have to be kept clean to maintain correct tape speed. Particularly older tapes will leave a heavy deposit of grime and iron-oxide on the rubber. At times the track left on the roller becomes so severe, that its hard polished surface, coating the rubber, will cause severe slipping. When tapes are played on the same machine or on another one, timing may be off, the program may sound slow or fast, and music will contain highly objectionable wows. Therefore, it is most important to keep rollers clean. Spare rollers and idlers should be kept on hand to replace worn-out ones.

A number of commercial cleaning fluids are also available for servicing tape recorders. These fluids must be tried by the individual user to determine their use and value to his own needs.

The meticulous maintenance kept by recording and broadcast services, might well be adopted by every tape recorder owner. Where the recording and playing is not done as heavily as in professional installations, maintenance can be done less often. However, the technique and precautions outlined here are based on practice and experience. What has become good for the professional services, should be reliable to the amateur or occasional recordist too.

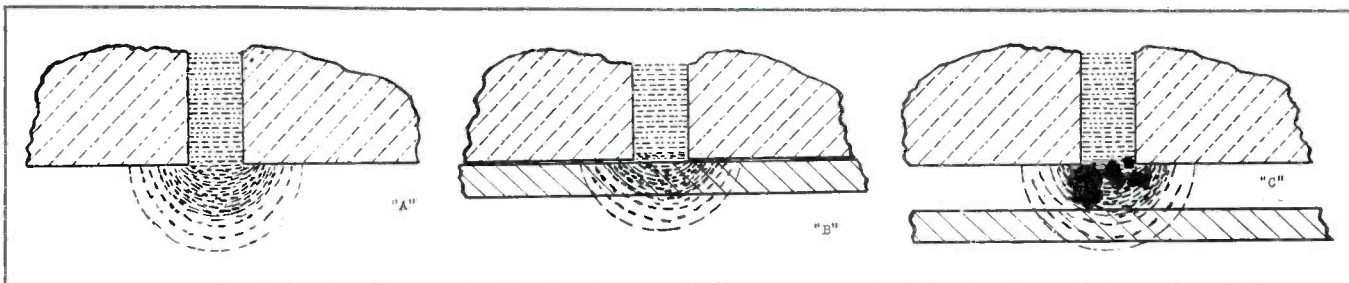

Left: This diagram illustrates the magnetic field created by a recording head. Middle: Again we see the same magnetic field as a tape passes through it. Right: Now there is a separation between tape and head caused by foreign particles. The tape passes only through the outer edge of the magnetic field causing a weak signal and a loss of high frequency.

Tape Copying Attachment

by Buford Frye

... with this device you will no longer have to depend on a second recorder.

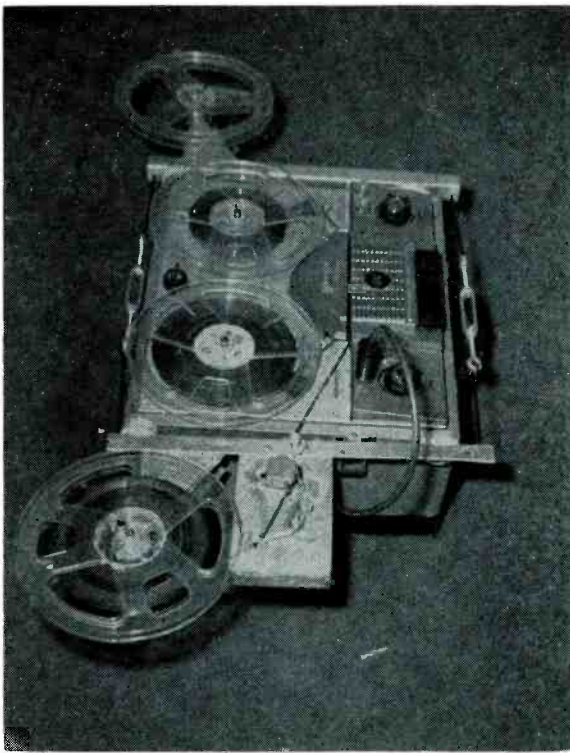

Recorder with tape copying set-up in place and ready to go. This device is relatively simple to install and reasonably inexpensive.

ALMOST all owners of tape recorders have, at one time or another, wished they owned a second recorder. Some have been fortunate enough to be able to afford a second recorder or a tape player. Others have been lucky enough to have a friend nearby with a recorder. But what of those who have longed for some way to make copies of their priceless tapes or try their hand at multiple recording or editing their dual track recordings without sacrificing one track? They have had to be content to read article after article about two-recorder techniques and dream of the day when they could purchase a second recorder.

The tape copying device described in this article should solve these problems, for it will make it possible for the person with one recorder to make copies of his tapes as easily as he could using two recorders. Using a few hand tools, the average person should be able to construct a copier which will give very good results. The copier as described herein is rather simple and relatively inexpensive. It should cost from ten dollars up, depending upon the choice of certain parts and upon how much a person could use from his junk box.

The general principle of operation is simple. The components consist of a tape supply reel, a play-back head assembly, a tape guide to detour the tape around the recorder erase and record heads and a tape take-up reel assembly. The copier pictured in this article was made for a Wilcox-Gay, but by following the same general principles one should be able to adapt it to any home recorder.

Top: Threading of tape with attachment. Head cover is removed. Playback head mounting can be seen in left foreground. Middle: Mounting of head as well as pressure pad arms and tape guides are seen in this rear view. Bottom: Shown here is the center tape guide and how it detours the tape around erase and record heads.

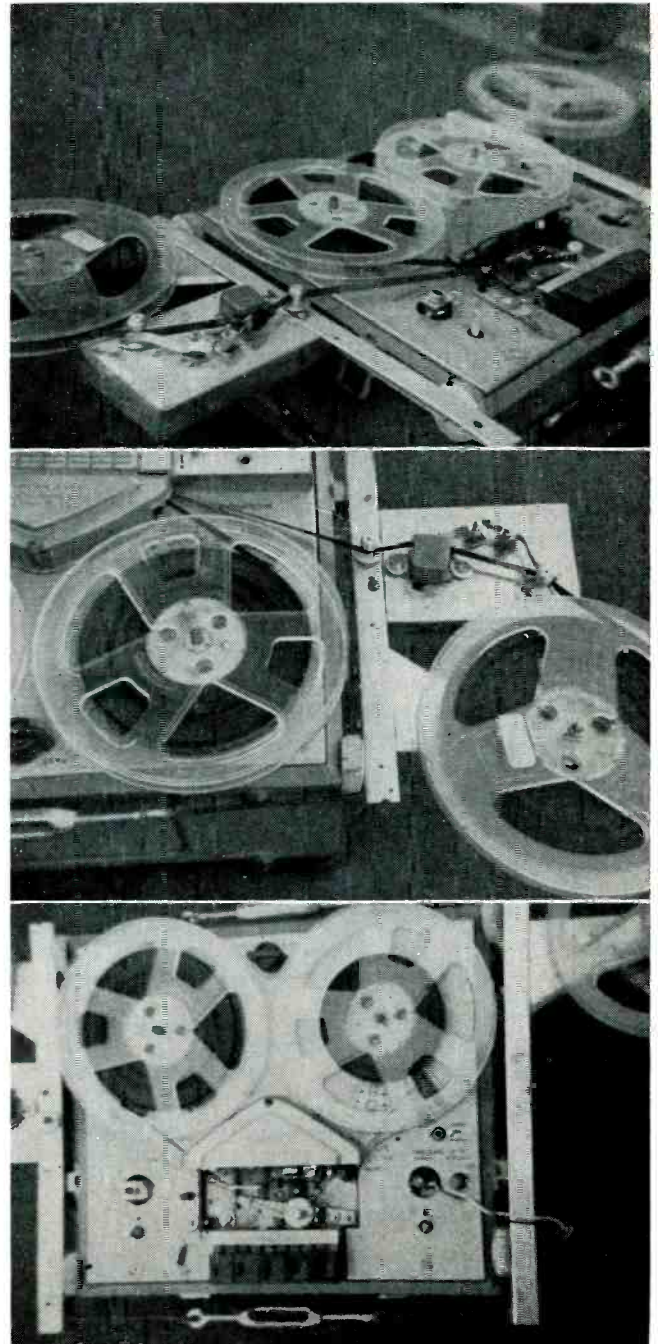

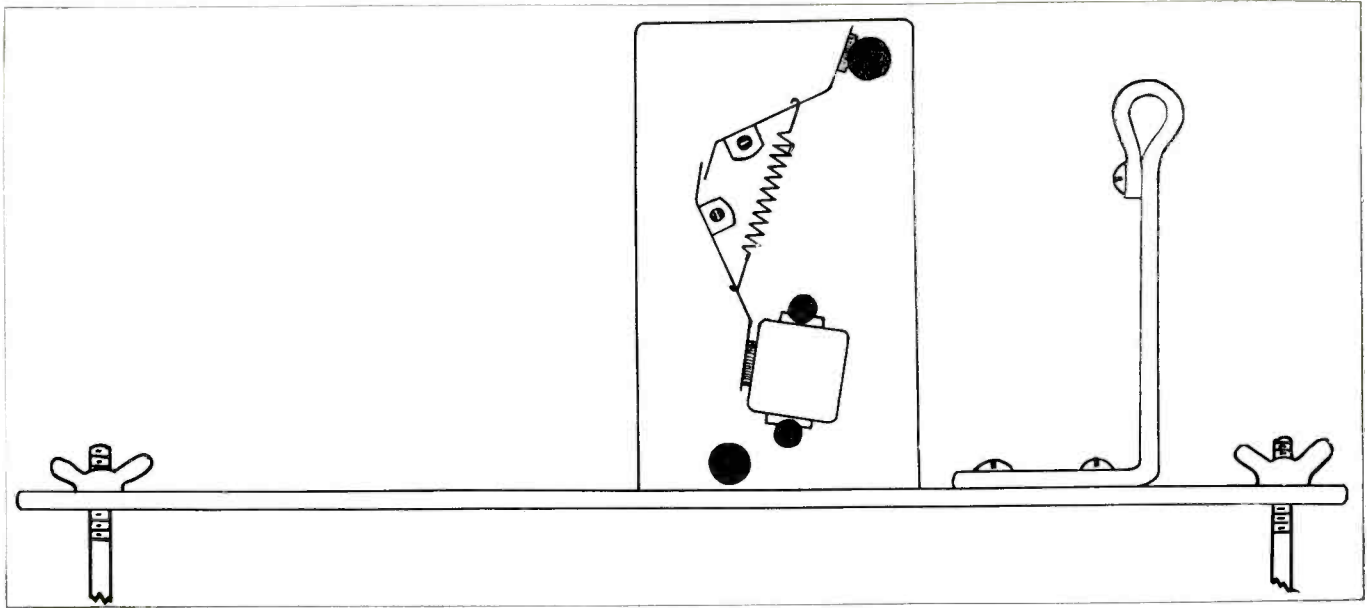

Looking down on the feed reel holder and head platform which attaches to the recorder. The wing nuts draw the machine tight against the recorder case, thus making it unnecessary to put screw holes or bolts in the recorder case. The arm at right holds the reel spindle. Interlocking pressure pads hold the tape against the guides and the head.

Before I begin the details of construction, it would perhaps be better to describe briefly the operation of the copier. The tape upon which you wish the copy to be made is placed on the recorder in the usual way for recording. No changes are made in its travel or position. The tape from which you wish to make the copy is placed upon the extra reel holders, threaded across the extra play-back head and through the guide which takes it around the recorder erase and record heads. The tape is then placed between the recorder capstan and rubber pressure roller along side the other tape. Thus when the recorder is started (in record position) both tapes will be pulled through the capstan at the same speed. The extra play-back head which is plugged into the recorder input will feed the signal into the recorder and an exact copy will be made.

A careful study of the pictures and drawings should be made as well as some investigation as to how you can adapt the copier to your recorder, before beginning work on the copier. Also a look through your junk box will probably locate several parts you can use. The copier can be made many different ways, depending upon your recorder make-up and upon the materials and tools with which you work.

One of the first things to decide is what tape play-back head to use. I used a Shure #816 and have found it acceptable. The head can be purchased for about eight dollars. There are many other heads from which to choose depending upon the price and quality wanted. Probably a good rule to follow would be to buy a head that is equal to the one used on your recorder. The type head will determine its mounting, the placement of tape guides and the use of pressure pads. These specifications should be supplied with the play-back head.

You can start construction on any part first, but I shall begin with the supply reel assembly. The bracket which holds the reel holder is, shown in the drawing, made from $\frac{1}{8}$ x 1 inch band iron. I made mine from sheet aluminum. Any suitable method can be used as long as it is sturdy. The supply reel holder is made as drawn for the take-up reel except that the portion below the brass bearing is

omitted on the supply reel holder. The metal disc can be soldered to the shaft or can be shrunk on by cooling the shaft and heating the disc. Several other methods of constructing these parts may be used. Also, these reel holders can probably be purchased as replacement parts for your recorder. A smaller shaft would be suitable if a $\frac{5}{16}$ cap is used above the disc.

The head platform for my copier was made by folding sheet aluminum over a frame of angle aluminum. It could probably be more easily made by bending a piece of heavier sheet metal in an L shape. The play-back head should be mounted as close as possible to the recorder for the further the tape travels, the more room for trouble. The head should be mounted as sturdily as possible since any movement between it and the recorder will cause flutter or wow.

The pressure pad arms are made from sheet aluminum. They are cut with a tab on either side, which are drilled and bent over so they will pivot on a small screw fastened to the platform. The drawing shows them overlapping so both will raise when one is pressed down.

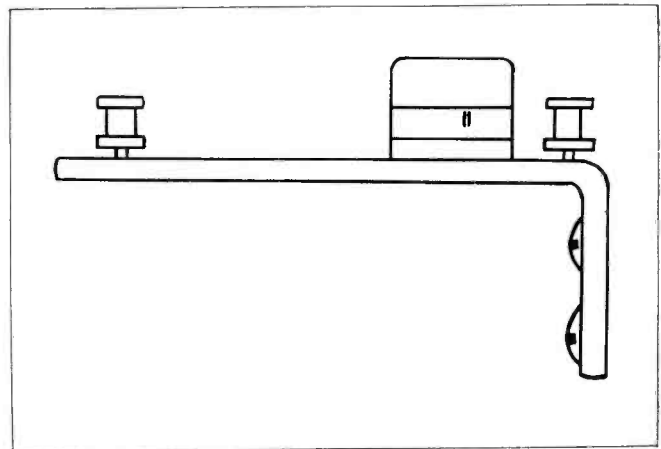

Side view of the platform holding the playback head. This may be made of heavy sheet aluminum or similar material. The head should be as close to the recorder as possible and sturdily mounted.

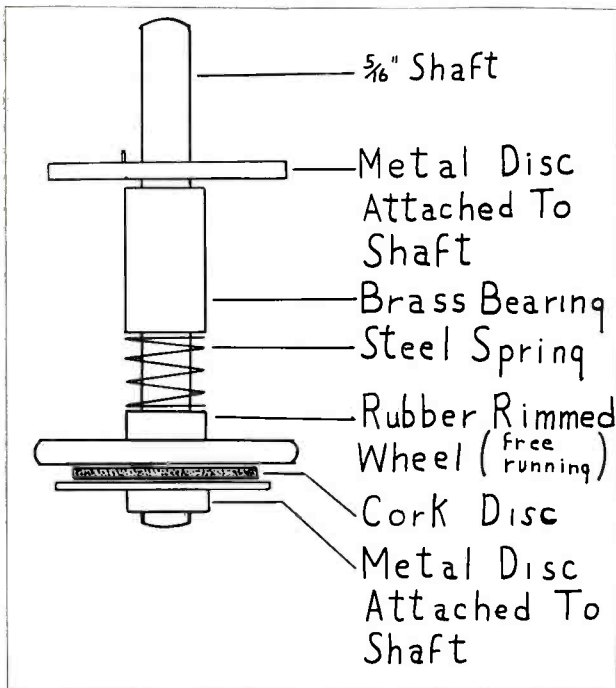

The take-up reel slip clutch assembly. The take-up reel should be kept as close to the recorder as possible to avoid tape tangles. The cork disc is used as a slip clutch to maintain tape tension for winding.

The tape guides can be made by using washers and short lengths of brass or copper tubing. These can also be turned on a lathe or purchased as replacement parts. The guides should be placed so as to give the tape the proper angle as required by the head. The center guide should be placed so the tape can go through the recorder capstan without passing over the record and erase heads. On some recorders, the center guide may not be needed. If used, it should cause the least possible angle of bend in the tape. This guide can be fastened upon a bracket by an existing screw if possible. The head cover may need to be removed unless the tape can be threaded otherwise.

The take-up reel can be omitted if you want to go to the trouble of rewinding 1200 feet of the tape from the floor everytime you copy a reel. This is not as insane as it seems. I copied several reels before I finished the take-up reel. However, I think a take-up reel is highly desirable, although it is the most difficult to make since it must be powered separately from the recorder.

The take-up reel should be placed much closer to the recorder than pictured. The closer it is the less likely that the tape will become tangled. The reel assembly must be made so that a steady tension will be kept on the tape at all times. This requires a means of power with a variable speed. I obtained this by using a cork-faced slip clutch as shown in the drawings.

For power, I used a single speed phonograph motor (obtainable from Lafayette Radio, 165-80 Liberty Ave., Jamaica 33, N. Y., for ninety-five cents). The idle wheel on this motor can be used for the rubber rimmed wheel shown on the reel shaft. The motor should be mounted on a pivot so that tension of a spring will keep the shaft in constant contact with the rubber rimmed wheel. The shaft of the motor can be filed down to reduce the speed if it turns the wheel too fast.

The slip-clutch is not too difficult to build. It would probably be easier if the shaft were made smaller than 5/16" below the disc. The bottom disc should be made with a set screw or should be tapped and the shaft threaded so the tension of the spring can be adjusted. Cork or felt can be used for the clutch facing. The motor can be wired with a separate switch mounted in the cord or upon the copier.

An over sized fan ought to be made for the motor to keep it cool. Also, a cover should be made for the motor and take-up assembly. This will guard against broken tapes, should the tape not wind upon the reel properly as well as giving a good appearance.

The mounting of the copier should be sturdy so that there will be no vibration of the reels or the playback head. The drawings and pictures show the copier fastened to the recorder by means of a turnbuckle on either side. The copier could be fastened directly to the recorder but most people would probably prefer not to mar the appearance of their recorder. The drawing shows the parts fastened to 1/8 x 1" band iron. The pictures show them fastened to angle aluminum. A much better method than either of these would be to use the turnbuckles but fasten the parts to a board about six inches wide. Rubber basin stoppers with the top cut off make good bumpers to go against the recorder. One of these at each corner of the board will cushion it and make the board good and steady when the turnbuckles are tightened.

On my recorder I find it necessary to copy with the volume control on full in order to get enough volume on the copy. I plan to add a preamplification stage between the copier and recorder. Some recorders may need this and others may not.

If constructed carefully and with good materials, this attachment should give much service and enable you to enjoy tape recording more than ever before.

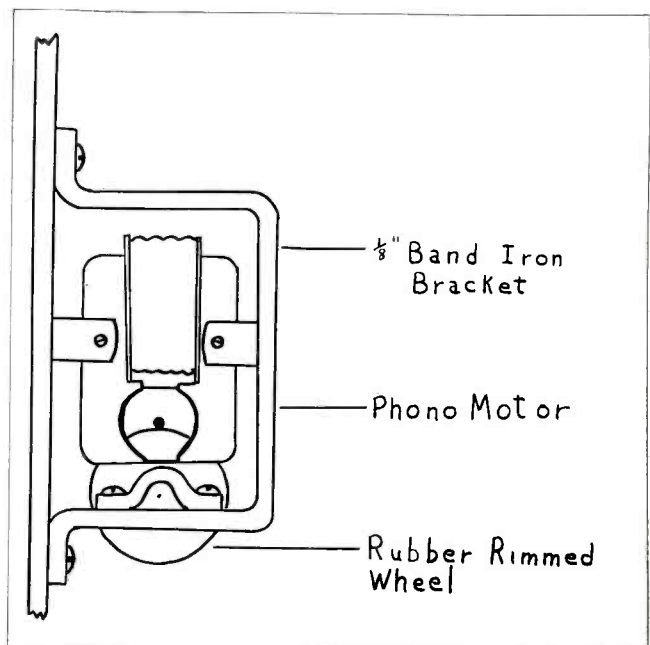

The drive for the take-up reel is a ninety-five cent phono motor mounted on a pivot to keep its shaft in contact with the rubber rimmed wheel shown in the drawing above. Spring tension provides the necessary pressure.

TAPE CLUB NEWS

We have recently been notified of a Japan Tape Pal Club, for anyone interested in tapesponding in either English or Japanese. At present, club membership is free and a directory and additional information can be obtained by writing to the club secretary, Mr. Shin Tanaka, Japan Tape Pal Club, 35 Sannomia—Cho, 2-Chome, Ikuta-Ku, Kobe, Japan.

In order to help new members get started in the club, Voicispondent Bob Crouse of Maryland, Potomac District Deputy, wants to compile a list of names of VS-ers who will answer tapes sent to them by anybody, and who will answer promptly. Once he has such a list, he can tell new members that they can send tapes immediately to certain older members. In this way there is no delay in welcoming in a new voicispondent and helping him get started. If you are willing to have a new member send you a tape on a 2 or 3 time basis, and will answer him interestingly and promptly even though he does not write first, drop Bob a card and ask to be put on his list.

Voicispondent George Benton, 3rd, has come up with an idea for those fellow club members who may have on hand some recorded tapes which they are tired of or simply do not prefer to have. He proposes to establish a recorded tape exchange whereby all members who have such tapes can send him a listing, and those who may wish to exchange one of their tapes for somebody else's can do so. There are still a few technicalities to be worked out, such as how everyone is to be told what tapes are available. This may, perhaps be published in The Voicispondent. Any members who are interested are asked to contact George at 350 Laguna Honda Blvd., San Francisco 27, Calif., and tell him the names and condition of any tapes they would like to exchange.

JOIN A CLUB

- TAPE RESPONDENTS INTERNATIONAL**
Jim Greene, Secretary
P. O. Box 125, Dept. T, Little Rock, Ark.
- THE VOICESPONDENCE CLUB**
Charles Owen, Secretary
Noel, Virginia
- WORLD TAPE PALS, Inc.**
Marjorie Matthews, Secretary
P. O. Box 9211, Dallas 15, Texas
- AUSTRALIAN TAPE RECORDISTS ASSOC.**
Jack A. Ferry, Federal President
Springbank Rd., Clapham, S. Australia
- UNITED RECORDING CLUB**
Richard L. Marshall, President
2516 S. Austin Boulevard
Chicago 50, Ill.
- THE NATIONAL TAPESPINNERS**
Carl Lotz, Secretary
Box 140, Peoil, Pa.
- THE BRITISH AMATEUR TAPE RECORDING SOCIETY**
Ted Yates, Secretary
210 Stamford Road
Blacon, Chesrer, U. K.
- AMERICAN TAPE EXCHANGE**
Stuart Crouner, Secretary
181 E. Main St.
Gouverneur, N. Y.

In the future, all British Amateur Tape Recording Society members will be known by tape stations, each station being prefixed with a "Call Sign" made up from their membership number. These pre-fixes are international, and are changeable by international convention only. For many years they have been and still are used by all radio amateurs and South Wales listeners. The pre-fixes are based on the country in which a member lives. This station coding is the fore-runner to future activities within the society. A master tape on these future activities and the station coding will shortly be available to members from the B.A.T.R.S. tape library.

The British Amateur Tape Recording Society has called upon those members who have the time to help record messages from relatives in the United Kingdom to kin in the Armed Forces stationed overseas for Christmas. Tapes would be provided for the recordings which would have to be made between three and four weeks prior to the holiday. We consider this to be a very worthwhile club undertaking, and hope its members will answer the appeal.

Another WTP club, a Writers' Club, has been originated. Its organizers are Mort Ginsberg of New York, Charles Aitken, Scotland, and Michael Coulter, England. The basic format is as follows: A member reads one of his manuscripts onto tape, allowing enough room for criticism at the end of the tape (about half an hour or so). He sends the tape to another member of the group who listens to the story and records his comments and any constructive criticism or marketing ideas. The tape is thus passed around until it is finally returned to the author. In this way the author ends up with his story recording, plus lots of commentary and valuable criticism. Interested club members are invited to contact any one of the three organizers listed above.

The Hadley School for the Blind recently established a recording studio in which World Tape Pal Mike Klein of Glenco, Ill. has taken a great interest. He plans to devote his spare time and equipment to lending any assistance he can to the studio. The Hadley School has been invited to join the club as a group and WTE tapes are being made available for school use. The new studio is intended to supplement teaching by braille rather than supplant it. Twenty-one language courses are offered. With tape, the student has an opportunity to hear correct pronunciation, as well as learn the rules of grammar.

American Tape Exchange member Arthur West of Commerce, Texas, has discovered a method of physical therapy through tape. It is designed for sleep treatment, and is useful for someone who is not too seriously ill. Members are invited to write to Arthur for information.

STEREO-TAPE CLOSE-OUT

Closing out our stock of stereo tapes.
Here's your chance to pick up a bargain or two. Send \$.50 for complete catalog of tapes available—cost of catalog applied to first purchase. Don't miss this opportunity.

CENTRAL STEREO CENTER
P. O. Box 9631 North Atlanta, Georgia

RECORDS FROM YOUR TAPES

Meetings, concerts, training aids, etc. economically re-recorded on permanent hi-fidelity discs. Professional quality—overnight service—all speeds—any quantity. Write for Free Folder and Prices.

RECORDED PUBLICATIONS LABS.
1556-1570 Pierce Ave., Camden 5, N.J.

TAPE RECORDERS

HI-FI COMPONENTS
Tapes—Accessories
UNUSUAL VALUES
Send for Free Catalog

DRESSNER
69-02 AA; 174 St.
Flushing 65, N. Y.

MERITAPE
Low Cost,
High Quality
Recording
Tape—in
boxes or cans.

RECORDED TAPE

A full line of stereophonic and monaural tapes from over 30 tape libraries. For FREE catalog, write—

MAL'S RECORDING SERVICE
Dept. TR, Box 37, Rockaway Park 94, N. Y.

A SOUND INVESTMENT

When we find one we don't hesitate. **HI-FI TAPE RECORDING Magazine** will pay many future dividends in recording and listening pleasure. Fill out the coupon below and get it in the mail. We'll be glad to bill you if your check book isn't handy at the moment.

2 Years \$7.00
1 Year \$3.75

HI-FI TAPE RECORDING

Severna Park, Md.

Please enter my subscription as indicated below:

- 2 years \$7.00
 1 year 3.75
 Payment enclosed. Bill me later.

Name

Address

City Zone State

NEW PRODUCT REPORT

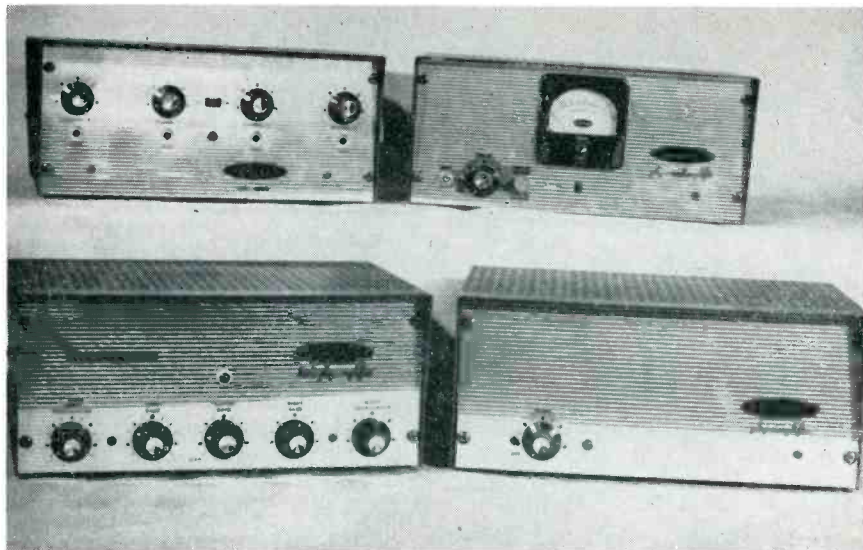

PENTRON TAPE COMPONENTS

... New Mike Mixer, Record/Play Preamp, Dual Channel Stereo Preamp and Playback Preamp for building-block construction of tape Hi-Fi Systems.

THE Pentron line of tape system components are designed as building blocks for a hi-fi system. They are integrated and matched to each other and are of similar appearance with black punched metal cases and bronze fronts with black knobs. All have the same physical dimensions so that they may be mounted in custom built home systems and have a uniform appearance.

While intended for use with the Pentron Tape Deck, the units will function with other sound sources such as record players, etc.

The Mike Mixer (upper left in the photo above) is a four channel pre-amplifier type mixer with each channel having its separate preamplifier to avoid loss of gain. The inputs include two "high" and two "low," the former suitable for crystal mikes or dynamic mikes. Input has an impedance of 1 megohm and the latter may be used for tuners, phono pickups, etc., which have a relatively high level of output. The microphone input has a gain of 8 db; the phono a gain of -22db.

The output is fed into the tape recorder and voice and music may be mixed and recorded on one channel on the tape.

This unit worked well in the tests and the gain is sufficient to use a relatively low level mike with a regular tape recorder. The unit has two stages of audio amplification. Frequency response on the unit tested was good.

The Record/Playback Preamplifier (upper right in photo) is designed for use with the tape mechanism. The unit

STAFF TESTED

Product: Pentron Hi-Fi Components

Prices: CA-11 Playback Preamplifier — \$39.95. CA-13 Play/Record Preamplifier — \$79.95. CA-14 Mike Mixer — \$39.95. CA-15 Stereo Dual Preamplifier — \$79.95.

Manufacturer: Pentron Corporation, 784 S. Tripp Ave., Chicago 24, Ill.

may be powered either by plugging it into a wall socket or taking power from the receptacle provided on the rear of the tape mechanism. The switch on the tape mechanism may be used to turn it on or off in addition to the switch on the unit.

To prevent accidental erasure, the preamp is equipped with a record safety interlock and it is necessary to push the button down before the record button can be depressed. After a recording is made the record button must be released. The machine should never be operated in fast forward or rewind with the record button depressed.

The drawing shows how the mechanism is connected to the record/play preamp with the red and black leads going to the head. Note also the ground wire between the two units to

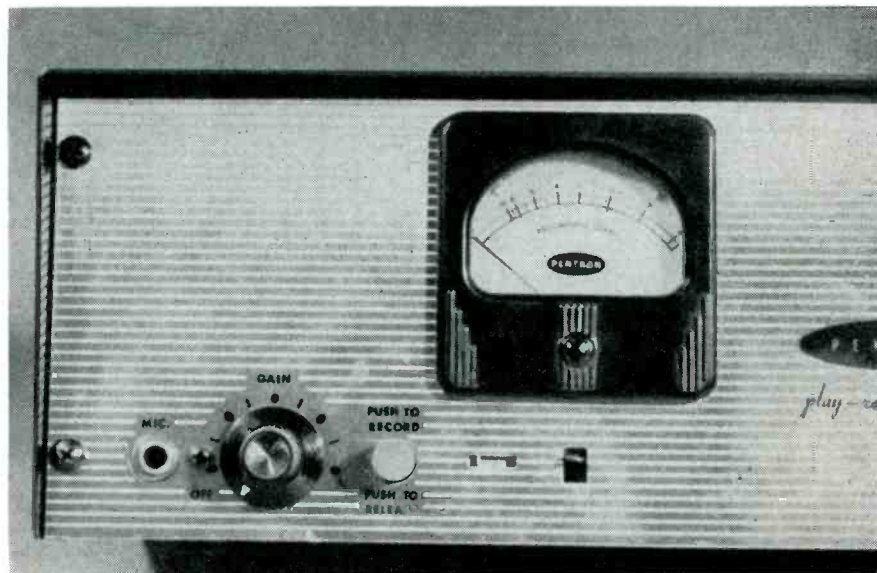

The face of the Record/Play Preamplifier showing the VU meter for recording level and the controls, which include a safety interlock to prevent accidental erasure.

eliminate hum. In addition, there is a hum balancing adjustment on the rear of the cabinet which may be turned in either direction to totally eliminate any hum present. An output is provided to the power amplifier and an input for recording from the radio, TV or phono. To monitor a recording, earphones may be plugged in the output jack.

For custom installation the rubber feet and metal case are removed and the unit mounted in a panel with a hole $4\frac{5}{8}$ " x $10\frac{3}{8}$ " and fastened by means of panel mounting screws. If the wood panel is not substantial a wood block or shelf may be constructed on the rear side and the unit attached by means of wood screws.

The Record/Playback preamplifier performed very well in the tests and would meet AA program requirements. The curve is compatible with the NARTB specifications. Equalization seems to be for the $7\frac{1}{2}$ ips speed.

The Stereo Dual Channel Playback Preamplifier (lower left in photo) is a dual channel preamp with individual gain and equalization controls for each channel. It may be used with either stacked or staggered heads. It also has a master gain control which raises or lowers the volume on both speakers once the balance has been set with the individual channel controls. As anyone who has used stereo will testify, this is a very desirable feature. The unit may be plugged into the AC line or may be attached to the tape mechanism and the on-off controlled with the tape mechanism switch.

A hum control, which should be adjusted with an insulated screw driver is incorporated in the back panel.

Identical in size with the units previously described, the Record/Playback Preamplifier can be mounted in the same manner for custom installation.

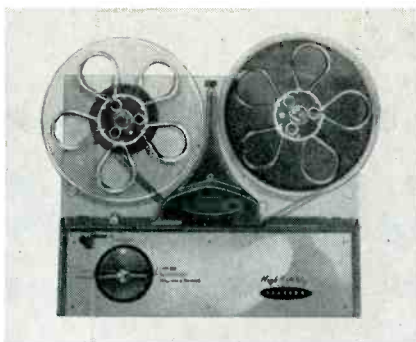

The Pentron Tape Mechanism, or deck, for which the components were primarily designed. Appearance matches component units.

Frequency response is more than adequate for any hi-fi installation and the unit worked well under test.

The remaining member of this building block family of components is the Playback Amplifier (lower right in photo). This is a straight playback preamp having only a gain control. It is suitable for connection to the tape mechanism for one channel playback or to be used in conjunction with a Record/Play preamp to provide the second channel for stereo.

This Pentron line was conceived with the idea of providing a number of similar units which could be added to as the budget allowed. The tape deck plus a Record/Play preamp becomes a monaural recorder. If stereo heads and a playback preamp are added, then you have a stereo machine. If you are interested in stereo playback only, a tape deck and dual channel amplifier provides it, etc. You will need power amplifiers and speakers to follow the preamps.

Taking the line as a whole we feel that dollar for dollar it is worthy of your consideration. The units are well built and attractively styled, adequate ventilation is provided on all.

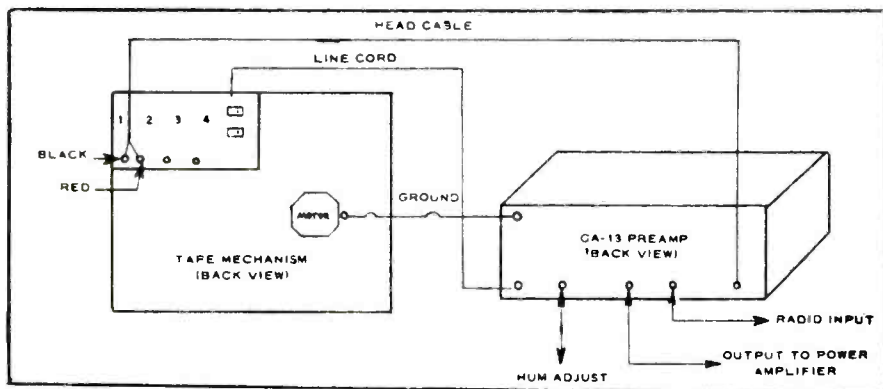

Hookup diagram for the Record/Playback Preamplifier. The unit may be switched on or off either with its own switch or from the main switch at the tape deck. Note ground connection to kill hum.

Last Chance

to buy an Add-the-Melody tape at the low \$8.95 introductory price.

The Add-The-Melody tape process has been taken over by another company and we have a limited stock for sale at this price. Act today!

ADD-THE-MELODY TAPE (Pat. Pending)

Hack Swain, whose Multee-Track recordings on the Livingston label created a sensation, now accompanies you on the electronic organ as you sing, whistle or play an instrument. For the first time YOU CAN HEAR THE COMBINED RESULT AFTERWARD and you can record your talents as many times as you like without destroying the accompaniment.

These new tapes can be used on any machine that has monaural record and stereo playback. As you listen to Hack's expert-accompaniment played from the lower track you add the melody yourself on the top track by singing, whistling or playing an instrument. Then play both tracks together in stereo fashion and there you are—with professional accompaniment. Synchronism is perfect. Can be recorded on stacked or staggered machines; can be recorded again and again without harm to the accompaniment.

Add-the-Melody tapes can be played on the following stereo playback machines: Ampro, Bell, Concertone, Ekotape, Ercona 77, Magnecord, Philco, Pentron, Revere, Seabreeze, Symphonic, V-M, Viking, Webcor, Wilcox-Gay, and Wollensak.

ADD-THE-MELODY TAPE #1

The Yellow Rose of Texas—Let Me Call You Sweetheart—I Want A Girl—Girl of My Dreams—Home on the Range—Shine on Harvest Moon—Put on Your Old Gray Bonnet—Carry Me Back to Old Virginia—When Irish Eyes are Smiling—Down by the Old Mill Stream—Wiffenpoof Song and Till We Meet Again.

All the tunes you know and love. If you can whistle, play an instrument or sing you'll get a million dollars worth of pleasure from this tape.

Only \$8.95

postpaid

From your dealer or

Hi-Fi TAPE RECORDING

Severna Park, Md.

Presenting . . . the new lightweight champion!

WOLLENSAK "1500"

HI-FIDELITY DUAL-SPEED TAPE RECORDER



DISTINGUISHED APPEARANCE!
Superbly elegant when open or closed. Handsome, modern styling in rich satin-chrome and off-white harmonizes with every decor.

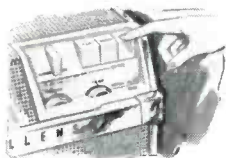

EASY OPERATION!
Simplified key-board controls. Handy, strikingly beautiful operating panel provides the utmost in operating ease.

ULTRA-POWERFUL!
10 watts push-pull audio output—four times greater than larger, less portable recorders. Ideal for auditorium use.



CONSOLE PERFORMANCE!
Tape live music or use in conjunction with a hi-fi speaker and tuner for a fine complete hi-fidelity system.



THE most magnificent, lightweight and compact tape recorder available—achieved with top-quality miniaturized components and all-metal airplane type construction. Measuring only 6½" x 10¼" x 11¾" and weighing a scant 18 lbs., it accepts 7" reels with playing time of three hours using long-play tape. Provides finest "Balanced-Tone" high fidelity with enough power to accommodate LARGE auditorium speakers. In addition to the outstanding features illustrated here, it includes: tape speeds of 3.75 and 7.5 i.p.s.; exclusive high speed rewind lever . . . two-level recording indicator . . . precision index counter; streamlined retractable handle and a host of other advantages. Complete with microphone, reels (one with tape) and cords. **\$199.50**

FREE DEMONSTRATION—Your authorized Wollensak Dealer will be glad to show you the "1500" and other fine WOLLENSAK Cameras and Projectors. See him now!

GUARANTEED SPECIFICATIONS

FREQUENCY RESPONSE
40-15,000 cps. ± 3 db. at 7½ ips.
40- 7,500 cps. ± 3 db. at 3¾ ips.

BOTH SPEEDS
Signal to Noise ratio — 48 db.
Wow and Flutter — less than 0.3%
Overall Distortion — less than 0.8%

High signal to noise ratio is achieved by use of two special hum balance potentiometers. High frequency equalization head alignment and bias current are also adjustable.



WOLLENSAK OPTICAL CO., CHICAGO 16, ILL.

WORLD RENOWNED FOR FINE OPTICAL EQUIPMENT SINCE 1899

TEEN TAPERS

BY JERRY HEISLER, National President



I've waited a long time to see it, but last week I got my chance. I saw a college student with a pocket tape recorder recording a lecture in class. You have seen this typical student use of a recorder mentioned in this column and in other columns, and it certainly isn't a new idea. I have never seen it actually in action though. It caused a sensation too when the professor saw the girl (I tipped him off). He was amazed at the idea, and being a man of considerable humor anyway, he made the most of it. He even offered to hold the microphone so she would get it all down and then he suggested that perhaps he would record all of his lectures and have them available at the library. Thus students could listen in anytime they were free. The discussion expanded to the point, where yours truly, suggested that we could all hire people to go to class for us and operate our recorders and we could all work in the daytime. Educational columnist, John Grady, might wince at this idea, but I predict that in the next few years pre-recorded college lectures will be available. It certainly isn't any harder to take than T.V. school courses. Not that we want to revolutionize education, but I couldn't help being struck by the possibilities of this application. I'd like to hear if any of you have any thoughts on this idea. But back to more basic things.

Christmas is in the air, and gifts are becoming a problem for many people. A sure fire gift item for you to give or receive, is a reel or two of recorded tape. The selection is growing ever wider, and now that more of the major-labels are getting into the field, all types of music are available. You might get a copy of the recorded tape catalog that our magazine puts out. Most dealers have it or can get it. This gives you a full descriptive list of what's available.

Pardon me for having a "two-track mind" (stereo, that is) but Christmas is also an opportune time to make the wonderful step into stereo. Practically every machine can be converted for under \$30 by using either the head put out by the manufacturer, or the Dactron Stera-dapter now available at many dealers.

Not long ago we were at the Hi-Fi show in Chicago where we were demonstrating our stereo chair. No fooling, we have an arm chair with a speaker built into each side so that you can play stereo tapes through it without disturbing anyone. We were using a recorder of standard home variety, when it happened to break down right in the middle of all of the excitement. We had many people waiting to see the chair, or should I say, hear it, and of course the repairman was nowhere to be found.

While frantically working over the ma-

chine, a young man happened to stop in. Seeing our predicament he offered to lend us a hand. We of course readily accepted his assistance. He took off his coat, rolled up his sleeves and, borrowing a screwdriver, proceeded to go to work on our "sick" machine. We were amazed at the boy's apparent knowledge of the things and even more amazed when after he had opened up the machine, he made a careful diagnosis of the machine and then proceeded to repair it.

Always having my eye open for a teen that knows about recording I got the boy into a conversation. It turned out his name was Ronald Moortgat, a 16 year old student at Chicago's Lane Tech high school. Ronald is studying radio-TV engineering and works part time for a friend of his who owns a radio-TV repair shop. In the course of his work in the shop Ronald had occasion to fix half a dozen or so recorders. He learned enough about them so that he feels he would like to go into some design work and engineering in the field of recording.

He reports that he and a friend have done quite a bit of work with sound effects and re-recording. He wants to sell his present machine and step up into a stereo type outfit. His mother, who watched proudly as her son amazed everyone with his knowledge of the innards of a recorder, told us that Ronald has his own shop at home where he has built many kits and some test equipment. She is encouraging him quite a bit and has high hopes for his success in the field. Judging from his knowledge at the age of 16, he will have quite a fine future in front of him. Since he's interested in design maybe we'll be able to get him to draw up a sketch for us such as the one that appeared recently. Nice going Ronald, and thanks for getting us back in operation at the Hi-Fi show. Ronald has a one year subscription to the Magazine now for his help in our hour of need.

We haven't heard from too many of you lately and want to urge you to write in your ideas. We had opportunity recently, to call on many dealers and it was gratifying to note that all of them were interested in the teens that shopped at their stores. You can be a very influential group in the field of recorder design and especially in the field of pre-recorded tape. Teens buy more records than any other group and we figure it's going to be the same way with tape. Let us know what you like and we'll pass it along to the right people. Believe me the manufacturers in this industry are real fine people with an eye to progress and they all want to know what you want.

I've got to send out a reel of tape to a tape pal, so we'll see you next month.

At Last! A practical answer to your cost problem. The World's Largest Tape Recorder Outlet and Service Lab now brings you a money saving . . .

STEREO TAPE EXCHANGE

We believe these benefits will astound and delight you:

1. EXCHANGE \$50 WORTH OF STEREO TAPE FOR ONLY \$1.35 PER REEL. And you may keep the tape as long as you like. It's yours! Yes, you may even choose the spectacular new releases of Capitol, Mercury, RCA Columbia, Livingston and over 30 other companies. Yet you've given up nothing, since the stereo reels you send in exchange are the ones you no longer want. Just like finding money on your shelves.

2. RENT STEREO TAPES FOR ONLY \$1.45 EA. If you have no tapes to exchange, you may rent them. Yes, enjoy stereo a full month at only 5c per day. Then exchange them for other tapes you want to hear. No longer must you listen to the same tapes month after month. No longer must you buy in the dark. Now you may try them, enjoy them, without buying. And if you do purchase, the rental charge is cancelled.

3. FREE! A TERRIFIC \$9.95 "STEREO" PARTY TAPE. This specially prepared 1200' "sing-a-long" tape does something new and hilarious . . . lets you record your friends singing familiar party favorites with spirited piano and organ accompaniment which you are hearing simultaneously from the other track. Then rewind and play back both tracks for the funniest, most memorable events of the party. Always the hit of the evening, and may be done again at all your parties without ever erasing the beautiful piano and organ accompaniment.

4. FREE! 4 STEREO CATALOGS. Gives not just titles, but full contents of every reel on the market. Mailed quarterly.

5. BUY STEREO TAPES, BLANK TAPE, ACCESSORIES & HI-FI COMPONENTS AT MAXIMUM SAVINGS. We guarantee your savings to be equal to any other nationally known club plan or mail-order catalog with manufacturer's approval. And you get our money back guarantee of satisfaction on all equipment purchased.

6. HIGHER TRADE-IN ALLOWANCES. Our huge service lab and facilities for converting recorders to stereo, plus our 10 showrooms enable us to rebuild and resell recorders in quantity. This means highest possible trade-in allowances to you. You need wait no longer for the thrill of stereo in your home. Enjoy the living presence now possible on such fine (stacked head) units as BELL and PENTRON, definitely best in the lower price range. Or for only a little more you may own a system of amazing quality, ruggedness, and durability, the TANDBERG STEREO. And for those who want only the very, very best, the stereo leaders of the world, the professional machine now at a price you can easily afford . . .

AMPEX Only 10% down
24 months to pay

Mail this coupon today:

All of the above privileges are yours for 1 full year for only \$6.95. This is less than value of the fabulous 1200' party tape alone.

STEREO TAPE EXCHANGE
Div. of Magnetic Recording Co.
344 Main St., Paterson, N. J.

Enclosed is check or M.O. for \$6.95 for 1 year's membership. Send party tape, catalog, and details for exchange and rental of tapes.

Send further info re: stereo tape exchange and tape rentals.

Send literature and prices on stereo recorders, hi-fi components, I am particularly interested in . . . (If trade-in, give make, model, age, and condition.)

NAME

ADDRESS

CITY ZONE STATE

SHOP OR SWAP

Advertising in this section is open to both amateur and commercial ads. TAPE RECORDING does not guarantee any offer advertised in this column and all swaps, etc., are strictly between individuals.

RATES: Commercial ads, \$.39 per word. Individual ads, non-commercial, \$.05 a word.

Remittances in full should accompany copy. Ads will be inserted in next available issue. Please print or type your copy to avoid error. Address ad to: Shop or Swap, Hi-Fi Tape Recording Magazine, Severna Park, Md.

HIGHEST QUALITY TAPE POSTPAID—on 7" reels—in boxes 1800' acetate 1/\$2.25, 3/\$6.00, 6/\$11.50. Double playing 1/2 mil. Mylar (4 hrs. @ 3 3/4 ips.) 2400' 1/\$4.50, 3/\$11.75, 6/\$25. Satisfaction guaranteed. Fidelitape, Dept. F, 1575 Thieriot Avenue, New York 60, N. Y.

FOR SALE—practically brand new! Ampex Model 350-P with 4 channel mixer in two carrying cases. 60 cycles. Price \$1200.00 complete. Murray Hill 5-4234. NYC.

EDISON CYLINDER records taped from 1888 Edison phonograph. For titles and prices: Johnson's, 434 Coles Mill Road, Haddonfield, New Jersey.

HAVE YOU SEEN the Edal 100? See page 15.

FAMOUS MANUFACTURERS CLOSEOUT—top quality, fully guaranteed tape 1200 ft. 1 1/2 mil acetate \$1.26—four or more \$1.39 each. 1800 ft. 1 mil acetate \$1.69—four or more \$1.87 each. Add 25¢ per order. Other tapes available. Hi-Sonic, P.O. Box 86, Dept. A, Kingsbridge Station, New York 63, N. Y.

AUDIO MIXER: Ideal, tape recorders, disc, etc. Inputs: 2—\$3.75; 3—\$4.75. Send for brochure. Ruby Recording, 520 5th Avenue, New York City.

DO FLYING SAUCERS, ghosts, magic, hypnotism, occult subjects interest you? Important information, free. Dave Matson, 103 Hampden, Upper Darby, Pennsylvania.

FOR SALE—3 speed professional tape recorder with built-in Hi-Fi Amplifier, assorted mikes and mixer. Several home recorders like new. 8-hour background music system complete. Bargain. L. M. Stone, Rt. 1, Arab, Alabama.

LEARN HYPNOTISM, SELF-HYPNOSIS from tape! Other helpful recordings! Free catalog! Drawer TR697, Ruidoso, New Mexico.

4TH GRADE SCHOOL CHILDREN (9 year olds) would like to tapespond with school children of other lands. Write or tape Mr. Cooper, c/o Key School, 25400 Jerome, Oak Park, Mich., USA.

\$100.00 WEEKLY Spare Time with a tape recorder! Fabulous new business. Entire country wide open! Record weddings, parties, sports events, stereophonic sound, sound-on-sound multiple recordings. Make radio commercials, sound effects. Have fun and make big money in the glamorous business of tape recording. Moneymaking facts free! Dixieland Publishers, Asheboro, 18, N. C.

LEARN WHILE ASLEEP with your recorder. Amazing book gives full instructions, \$2.00. Guaranteed. Research Association, Box 610TR, Omaha.

WANTED—SOUNDCRAFT TAPE SPLICER—New or used. Grant, 2336 N. Commonwealth Ave., Chicago 14, Illinois.

FOR SALE: Webcor model BP 2640-1A high fidelity tape recorder with input, output, and patch cords for recording from almost any source, plus mike, 7.5 and 3.75 speeds. Used only five months. Best offer over \$100. C. A. Hughes, Jr., 311 Lake St., Elmira, N. Y.

"REPORTER" portable, battery, recorder; 7 1/2 speed; with speaker, microphone, erase head, leather case. John Moyer, Chicago Museum, Chicago 5, Illinois.

YOUNG MAN (21) will tapespond with young person, male or female, interested in various types of music and films. Detest snobbishness. Ronald Wanser, 514 Williams Ave., Brooklyn, New York.

SWAPPING TAPE! Twelve 15" and twelve 7" reels of tape, some unspliced, for movie equipment, slide projector, Hi-Fi phono, good recording mike

or what have you? Hank Siegel, 13 Ridge Road, Lyndhurst, New Jersey.

PENTRON HF400, Very Good condition, used very little. New Sept., 1956. \$140. Quality AM-FM Tuner, built June, 1957, \$25. Richter, Box 701, Morristown, New Jersey.

MUSIC TEACHER would like to tapespond especially with people interested in music. Mildred Platt, 247 North Main St., Southington, Conn.

BERLANT CONCERTONE MODEL 22ST, one month old, still in warranty period—New \$804.00, will sacrifice \$575.00. Arthur J. Rogers, 59 Colonial Avenue, White Horse, Trenton 10, N. J.

PROFESSIONAL DUPLICATING Tapes, records, transcriptions. Berlant and Viking equipped. Write Midwest Recording Enterprises, Box 207, Lombard, Illinois.

SACRIFICE—VM 710 tape recorder. Used only by myself personally. Absolutely perfect in every respect. Will re-pack and ship complete in factory carton. Exactly one-half price. Wellmaker, 1053 East 13 Street, Brooklyn 30, N. Y.

FOR SALE: Shure ribbon microphone, Model 333, Concertline with Electro Voice transformer matching to Hi-Z. Shure's best mike. Used only a few times. Good as new, \$140 COD. R. W. Vogt, Tribune, Kansas.

HIGH FIDELITY recording tape. 1800' 7" reels, boxed. Price each in lots of 1/\$2.49, 3/\$1.89, 6/\$1.84, 12/\$1.79, 24/\$1.74, 48/\$1.72, 100/\$1.69. Guaranteed top quality. Please include postage. Catalogue. Broadcast Tape, P.O. Box 231T, Wallingford, Conn.

EXPERT RECORDER REPAIR service; recorders bought and sold. Special, Pillow speakers, \$4.95, with complete hookup assembly. Excellent for playback of study material without disturbing others. Tape Recorder Sales Company, 433 South Wabash Avenue, Chicago, Illinois.

PRAYER FOUNDATION is collecting inspirational and sacred music to supplement religious tapes for shut-in work. Send titles we may copy. Box 2630, Phoenix, Arizona.

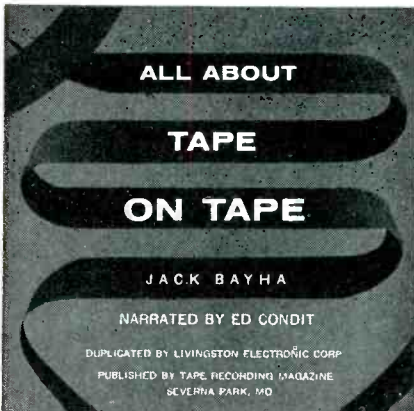

Now Hear This . . .
The World's First Tapebook
 . . . authored by Jack Bayha . . . a book to which you listen . . . the first book specifically designed and produced on tape instead of the printed page. . . . Now you can actually HEAR what good recording, over-recording, wow, flutter, distortion, wrong mike placement, etc., sound like. A test section allows you to adjust the head of your recorder for best results. Chapters include: How a tape Recorder Works. A Demonstrated Glossary, Recorder Operation, Home Recording, Field Recording, Low Impedance, Microphones, Recorder Maintenance and Testing.
 . . . Playing time of the Tapebook is one hour. Accompanying each reel is a 28 page booklet containing 80 illustrations to supplement the spoken word. It is unique, enjoyable and instructive.
Order Your First Edition Copy Today
 7 1/2 IPS, 7" Reel, Dual Track ..\$6.95 postpaid
 3 3/4 IPS, 5" Reel, Dual Track ..\$5.95 postpaid
 Including a 28 page manual of illustrations

We specialize in **TRADE-INS** — highest allowances — Ampex, Berlant, Crown, Ferragraph, Presto, Pentron. Hi-Fi components, accessories. Catalog.
BOYNTON STUDIO
 10 Pennsylvania Ave., Dept. TR
 Tuckahoe, N. Y. Tel. SP. 9-5278

TAPE RECORDERS
 EXCEPTIONAL VALUES
HI-FI COMPONENTS
 NATIONAL BRANDS
 WRITE FOR FREE CATALOGUE
CARSTON 215-C E. 88 ST.
 NEW YORK 28, N. Y.

FOR STEREO OWNERS

We are now offering the Hi-Fi Tape Recording Catalog of Stereo Tapes. This is available on Subscription—four issues for one dollar. It is revised and issued quarterly.

- Lists all available stereo tapes.
- Complete description of each tape—no more guessing when you order.
- Presently lists 656 tapes from 40 companies.

USE BLANK BELOW TODAY

STEREO TAPE CATALOG
 Severna Park, Md.

Please enter my subscription to the Stereo Tape Catalog. I enclose \$1.00.

Name

Address

City Zone State

SPECIFICATIONS

ALL VIKING DECKS

frequency response: 30 to 14,000 cps plus, at 7½ ips. 40 to 7,000 cps plus, at 3¾ ips.
 signal-to-noise: 55 db or better.
 flutter: 0.2 percent average.
 long term speed regulation: ½ of 1.0 percent.
 tape speed: 7½ ips (3¾ ips available by changing belt to smaller groove on motor pulley).
 maximum reel size: 7"

record/playback head characteristics: track width .085 inch. Gap width .0016 inch. impedance 2000 ohms at 1000 cycles. Double coil hum bucking winding. Mu-metal shielded. Output 2.5 mv.
 recommended bias current: .8 ma. at 681 c.
 in-line head characteristics: (VIKING'S own in-line head) same as above.
 erase head characteristics: track width .125 inch, double gap (each .005 inch), inductance 53 mh. at 1 kc, erase 60 db at 68 cc.

MORE PERFORMANCE PER DOLLAR
THESE ARE THE REASONS WHY:



Ultra-linear transport . . . flutter and wow completely below audibility.

Short-gap record and/or playback heads for extended range . . . Double-coil (hum-bucking) record and playback heads for minimum hum. Double-gap erase heads for *dead quiet* erase.

The finest of bearings, and the ultimate in machining tolerances in capstan and drive members — *where precision counts.*

Rugged simplicity for enduring performance.

Physically independent amplifier components for increased flexibility and minimized hum pick-up

Very high erase-bias oscillator frequency permits extended range recording without bias intermodulation.

NARTB equalization. Physical separation of mechanical and amplifier components, plus clean design, eliminates need for roll-off of lower (*hum*) frequencies.

SPECIFICATIONS

RP61 SERIES PREAMPLIFIERS

frequency response, playback: 30 to 14,000 cps ± 2 db.
 frequency response, record-playback cycle: 30 to 12,000 cps ± 3 db.
 distortion (tapes recorded 12 db below saturation) less than 2% within specified frequency range.
 internal signal-to-noise ratio: 60 db minimum all units.
 equalization: modified NARTB

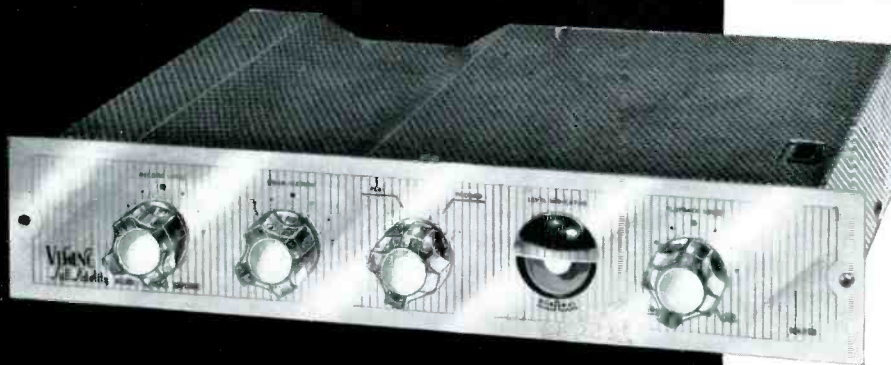

⊛ Ask your dealer for a Viking recording and playback demonstration before you buy any other recorder.

recording channel gain: low level input. Requires .002 volt rms at 400 cycles for recording level 8 db below saturation. (High level input, .3 volts rms.)
 playback channel gain: 55 db.
 recording inputs: high impedance microphone (62 db overall gain) and high impedance radio or phono input (32 db gain).
 bias frequency: 68 kc.
 output: 1 volt, high impedance.
 tube complement: 1-12AX7, 1-12AU⁶A, 1-12AV7, 1-6X4, 1-6E5 Indicator.



Viking OF MINNEAPOLIS
 9600 Aldrich Avenue South, Minneapolis 20, Minnesota
 EXPORT DIVISION: 23 Warren Street, New York City 7, New York
 Cable: SIMONTRICE, NEW YORK (All Codes)

C
O
M
P
O
N
E
N
T
S
W
I
T
H
T
H
E
H
I
G
H
R
P
F
A
C
T
O
R*

Twice as strong!

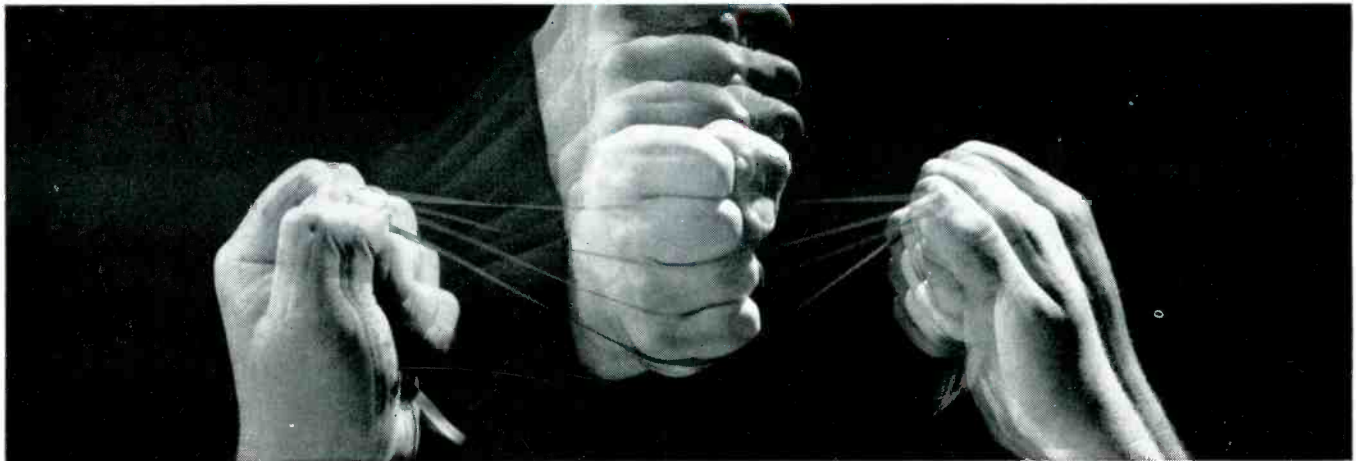

Plays twice as long!



New 200 "SCOTCH" Tensitized Double Play Tape has everything!

At last! A long, long playing tape you don't have to pamper! New 200 "SCOTCH" Brand Tensitized Double Play Tape records as much as two reels of standard tape. What's more, its $\frac{3}{4}$ mil polyester backing has been tensitized by an exclusive process so this new tape is twice as strong as any conventional extended play tape and won't stretch! Get a reel of new 200 "SCOTCH" Brand Tensitized Double Play Tape from your dealer now. You'll find it's well worth the slight extra cost.

Before You Buy It, Try It! Test 200 Tape's strength for yourself! Ask your nearby dealer for the free "Scotch" Brand strength test kit.



MINNESOTA MINING AND MANUFACTURING COMPANY

...WHERE RESEARCH IS THE KEY TO TOMORROW



The term "SCOTCH" and the plaid design are registered trademarks for Magnetic Tape made in U.S.A. by MINNESOTA MINING AND MFG. CO., St. Paul 6, Minn. Export Sales Office: 99 Park Avenue, New York 16, N. Y. © 3M Co., 1957